

Global Sea Level Observing System (GLOSS) Implementation Plan - 1997

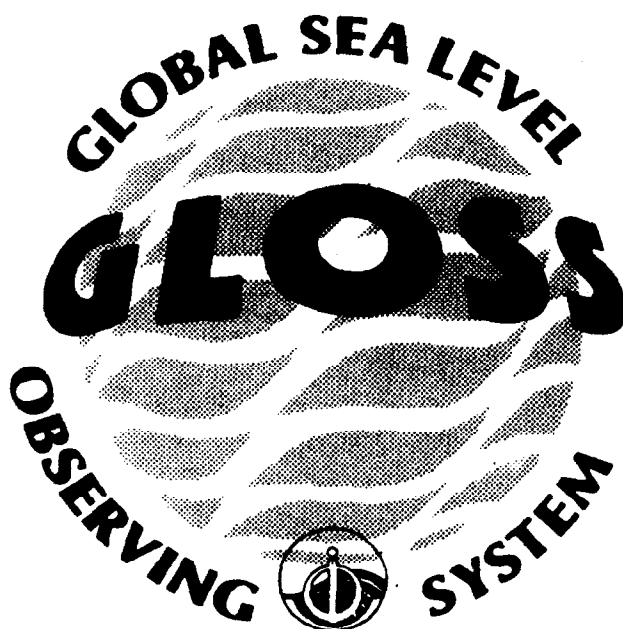

The designations employed and the presentation of the material in this publication do not imply the expression of any opinion whatsoever on the part of the Secretariats of UNESCO and IOC concerning the legal status of any country or territory, or its authorities, or concerning the delimitations of the frontiers of any country or territory.

For bibliographic purposes, this document should be cited as follows:

Global Sea Level Observing System (GLOSS)
Implementation Plan - 1997
IOC Technical Series No. 50, UNESCO 1997
(English)

Published in 1997
by the United Nations Educational,
Scientific and Cultural Organization
7, place de Fontenoy, 75352 Paris 07 SP

Printed in UNESCO's Workshops

© UNESCO 1997
Printed in France

TABLE OF CONTENTS

	Page
EXECUTIVE SUMMARY	1
1. Introduction	3
2. Layout of the GLOSS Implementation Plan 1997	4
3. Scientific and Practical Applications of Sea Level Information	5
3.1 Ocean Circulation	5
3.2 Long Term Sea Level Changes	5
3.3 Operational Uses and Coastal Engineering Applications	6
4. Stated and Implied Requirements for Sea Level Monitoring from Ocean and Climate Study Groups and Research Programmes	8
4.1 Intergovernmental Panel on Climate Change (IPCC)	8
4.2 World Climate Research Programme (WCRP)	8
4.3 The Global Ocean Observing System (GOOS)	10
4.4 The International Geosphere - Biosphere Programme (IGBP)	11
4.5 The International Lithosphere Programme (ILP)	11
4.6 Requirements within Regional and National Activities	11
5. The Global Sea Level Observing System (GLOSS): Present and Future	13
5.1 GLOSS Tide Gauges	14
5.2 Geocentric Co-ordinates of Tide Gauge Benchmarks	22
5.3 Satellite Altimetry and GLOSS	23
6. Measurement Techniques and Requirements	26
6.1 Tide Gauges	26
6.2 Geocentric Co-ordinates of Tide Gauge Benchmarks	27
6.3 Altimeter Data	28
7. Data Collection, Exchange and Archiving	31
7.1 Tide Gauge Data	31
7.2 Geodetic Data for Monitoring Vertical Land Movements	33
7.3 Altimeter Data	34
7.4 Other Data Sets for Sea Level Research	35
8. Sea Level Data Sets, Products and Services of Major Centres	36
8.1 PSMSL	36
8.2 WOCE Sea Level	37
8.3 University of Hawaii Sea Level Centre	37
8.4 National Tidal Facility, Flinders University	38
8.5 University of São Paulo (USP)	39
8.6 International Hydrographic Organisation	39
8.7 Altimeter Data Centres	39
9. Other Regional Sea Level Projects	41
9.1 Monitoring System for Sea Level Measurements in the Mediterranean (MEDGLOSS) (CIESM/IOC)	41
9.2 Other European Sea Level Activities	41
9.3 Caribbean Activities	42
9.4 IOC Regional Committee for the Central Eastern Atlantic (IOCEA)	42

9.5 Indian Ocean Activities	43
9.6 Operational Sea Level Centres	44
10. Training, Education and Mutual Assistance (TEMA) within GLOSS	46
11. Personnel Involved in the Management and International Coordination of GLOSS	48
11.1 National Contact Points for GLOSS	48
11.2 Regional GLOSS Co-ordinators	48
11.3 GLOSS Technical Secretary	49
11.4 IOC GLOSS Group of Experts	49
11.5 GLOSS dATA Co-ordination Panel	50
11.6 GLOSS Technical and Scientific Consultants	50
12. Obligations of Member States which are Committed to GLOSS	52
References	53
Figures	60

ANNEXES

- I. Intergovernmental Oceanographic Commission Questionnaire on Commitment to the Global Sea Level Observing System
- II. Most recent year of sea level data submitted to the PSMSL from GLOSS stations as of October 1996
- III. International Study Groups with Sea Level Components
- IV. List of stations in GLOSS-LTT, GLOSS-ALT and GLOSS-OC
- V. List of E-mail, FTP and WWW addresses
- VI. The GLOSS Station Handbook CD-ROM - July 1996
- VII. Summary of Data Sets and Products
- VIII. Summary of Tide Gauge/Meteorological Stations in the Intra-Americas Sea May 1996
- IX. List of National and International Contacts
- X. Selected Acronyms

EXECUTIVE SUMMARY

Sea level measurements, both at the coast and in the deep ocean, are required for a wide range of scientific research and practical applications. For example, sea level measurements can be used by oceanographers to infer changes in the ocean circulation, a major component of the Earth's climate system. In turn, it is known that rising sea levels and the associated risks of coastal flooding could be consequences of changes in that system.

The Global Sea Level Observing System (GLOSS) was established by the Intergovernmental Oceanographic Commission (IOC) in 1985 to monitor global levels, and also to help to develop national capabilities to assess and anticipate changing risks. The basis of the first GLOSS Implementation Plan, published in 1990, was the establishment of a network of approximately 300 tide gauge stations distributed along continental coastlines and throughout each of the world's island groups. However, since 1990, several major technical developments have taken place, most notably in the ability of satellite radar altimetry to provide reliable and routine measurements of near-global sea level changes. Consequently, the present document provides a complete re-assessment, rather than an update, of requirements for GLOSS, together with specifications for each component of the system.

The specific elements of the GLOSS now include:

- (i) A global tide gauge core network;
- (ii) The recognition of the special importance of sites, hitherto in GLOSS or not, with long historical records suitable for the detection of long term sea level trends and accelerations;
- (iii) A calibration system for radar altimetry based on a subset of the gauges in (I);
- (iv) A further subset of the gauges in (I) suitable for monitoring aspects of the global ocean circulation;
- (v) GPS monitoring of land levels at gauge sites;
- (vi) A programme of ongoing altimetric coverage of the global ocean;
- (vii) Provision of modern methods of data acquisition and exchange;
- (viii) Programmes of training based on formal courses and the wide availability of training information; and
- (ix) A set of programmes of research at regional as well as global level.

Each component of GLOSS complements others. For example, geocentrically-located tide gauge measurements can be employed to provide cheap and ongoing calibration of radar altimeters. Measurements of sea level changes at the coast, where people live, by means of conventional gauges complement the large scale coverage of changes in the deep ocean by means of altimetry. Data on vertical land movements obtained both at the coast and inland by the new geodetic techniques can be used to develop new models of the solid Earth which in turn can be used to predict which parts of the coast are susceptible to long term submergence or emergence. More generally, the advanced research products provided by the high technology systems have to be complemented by relatively straightforward, practical products for users and planners of the coast.

Although techniques may have evolved, the main scientific requirements for a GLOSS have not. In brief, they remain the need to monitor, and thereby eventually to contribute to an understanding of, sea level changes on timescales from hours (ocean tides, surges etc.) to decades (climate change). The requirements are derived from the recommendations of international scientific studies, such as the Intergovernmental Panel

on Climate Change (IPCC), from the observational requirements of various parts of the World Climate Research Programme (WCRP), and from the frequently-stated concerns of many States that parts of their coastlines are potentially threatened by significant sea level change.

Within an IOC context, GLOSS, as an existing operational system, will contribute to the Global Ocean Observing System (GOOS), particularly its climate, coastal and operational services modules, through the progressive development of the sea level measurement network, data exchange and collection systems, and preparation of sea level products for various user groups.

More generally, GLOSS is fully supported by the United Nations Framework Convention on Climate Change (FCCC), of which Article 5 (b) calls upon the Parties to the Convention to "support international and intergovernmental efforts to strengthen systematic observation and national scientific and technical research capacities and capabilities, particularly in developing countries, and to promote access to, and the exchange of, data and analyses thereof obtained from areas beyond national jurisdiction".

1. INTRODUCTION

In 1985 the Intergovernmental Oceanographic Commission (IOC) initiated the Global Sea Level Observing System (GLOSS), a programme for the provision of high quality sea level information for international and regional research activities, as well as for the support of practical applications at regional and national level. GLOSS was based on a global network of approximately 300 tide gauges, of which over 250 were operational by the mid-1990s, and the characteristics of the network as a whole included permanence, high vertical precision and stability, and the flexibility to develop as requirements evolved.

Since the Implementation Plan for GLOSS (hereafter called simply "the Plan") was published in 1990 [1], GLOSS has become established as an extremely successful IOC activity. More sea level data are now available, thanks to more gauges being installed where few existed previously. For example, installations have been made at sites in polar regions, sometimes in extreme climatic conditions, and at remote ocean islands. Data are also of higher quality, thanks to increased attention to quality control resulting from the availability of software packages for data analysis, and to the organisation of training courses on aspects of tide gauge operations. Data are more timely, thanks to modern means of communication. Tide gauge sea level data are being complemented by information on land levels, as a result of the application of new geodetic techniques. Meanwhile, there has continued to be extensive scientific and popular interest in the products of the research activities which have made use of the sea level data. Bibliographies of GLOSS-related publications give some idea of the extent of activities within the programme since 1990 (Section 8.1 and Annex VI).

As in many other areas of science, the decade since GLOSS was first established has seen the development of new techniques capable of application to the field of research. In the case of sea level studies, there have been developments in the design of advanced automatic tide gauges, in satellite radar altimetry, in the Global Positioning System (GPS), in absolute gravity and in several other technologies. In addition, the Internet has revolutionised data exchange methods.

Even though techniques may have evolved, GLOSS as before has only the one main objective. That is to provide a long term strategic system for the monitoring of global sea level changes. The system will be based upon proven methods as well as upon a number of advanced technologies, and will provide products suitable for a variety of users, including governmental bodies, coastal engineers, international scientific programmes, and the general public. The global system will inter-link with regional and national sea level systems, and will thereby enable the transfer of new techniques and measurement standards.

The 1990 Plan was the culmination of a series of consultations with relevant international agencies and programmes, and of task team studies initiated by IOC. In 1996, the IOC Group of Experts on GLOSS was asked by the Executive Secretary of IOC to undertake a similar set of consultations, and to prepare a new version of the Plan which would define the GLOSS programme into the next century. This Plan was reviewed by the Fifth Session of the Group in March 1997 and, upon its recommendation, was adopted by the XIX Session of the IOC Assembly in July 1997.

2. LAYOUT OF THE GLOSS IMPLEMENTATION PLAN 1997

Any programme which is global in extent, with many elements, and which seeks support from governmental and intergovernmental agencies has to be based on the clear needs of many countries, and to possess feasible means of implementation. The need to understand sea level changes, and the case for global sea level monitoring, have been made by many scientific working groups and governmental agencies, especially by those of countries with large centres of population or infrastructure near to the coast. A summary of the main scientific and practical applications of sea level information, and of the recommendations of various research study groups is included in Chapters 3 and 4. (More lengthy reviews of sea level research can be found in the literature [2,3]).

In Chapter 5, the elements of a system (GLOSS) which is designed to meet the requirements for global sea level monitoring are described. Progress in the tide gauge elements of the system during the first years of GLOSS are reviewed, together with proposals for how the role of gauges will change in the future. Satellite radar altimetry and the Global Positioning System (GPS), which were considered to be techniques of peripheral importance in 1990, are now discussed in greater detail. Chapter 6 briefly reviews technical aspects of each of the main techniques.

Chapter 7 proposes methods for data collection, exchange and archiving for GLOSS, making use in particular of modern developments in computer networks. The aim of such data collection is to facilitate advanced research and the production of a range of useful products. Chapter 8 summarises some of the GLOSS products and services available now, both as a guide to any reader who is unaware of GLOSS's accomplishments so far, and as a pointer to the many superior products we anticipate GLOSS will generate in future. Chapter 9 also refers to GLOSS products within the context of regional sea level activities.

Chapter 10 describes the various training elements of GLOSS so far, which will be enhanced considerably in future. Training is now on a much firmer basis than it was a decade ago. Courses then were primarily concerned with the technical details of operating float gauges. Of course, such topics are still discussed, but now there is as much concentration on sea level data quality control via software packages, on the complementary uses of altimeter data, and on the scientific and practical products which the data can provide. No doubt training methods will evolve in the future as, for example, it becomes possible to provide full sets of training materials on CD-ROM.

Chapter 11 gives a guide to the organisation of the GLOSS programme including the roles of National and Regional GLOSS Contacts, the GLOSS Technical Secretary and the IOC Group of Experts on GLOSS. Any of the contact persons named in this report should be able to provide further details of GLOSS if requested. Chapter 12 is the last but possibly one of the most important sections of this report. GLOSS is an intergovernmental project, and can function efficiently only with the support of IOC Member States. In this chapter, the obligations of countries which are committed to GLOSS are listed, while a questionnaire by means of which commitments can be expressed to the IOC Secretariat is contained in Annex I. Of course, it is realised that full commitments can be made only if the means to undertake them are available, and that there are many considerations, not least for training (Chapter 10). Commitments in principle are just as important as full commitments as long as there is a genuine intent on dialogue with IOC and the wider GLOSS community.

3. SCIENTIFIC AND PRACTICAL APPLICATIONS OF SEA LEVEL INFORMATION

The data provided by a global sea level monitoring programme are needed as basic information across a wide range of scientific research, as well as for many practical applications.

3.1 OCEAN CIRCULATION

Oceanographers would like to know the global 3-dimensional pattern of ocean currents induced by meteorological and thermohaline forcings. Fortunately, this complete pattern can be inferred to some extent from observations of the surface circulation alone via its "sea surface topography" (SSTOP), or sea level signal. A large part of the surface circulation is in geostrophic balance with the ocean's surface pressure gradient (or SSTOP gradient) in an analogous fashion to the way winds are balanced by air pressure gradients in the atmosphere. Consequently, if one can measure precisely the mean SSTOP and its temporal variability, then one will know the mean surface circulation and its variability.

The SSTOP is a surface which is the difference between a time averaged mean sea surface (MSS), as measured by precise altimetry or geocentrically-located tide gauges, and the geoid, which is the surface the ocean would have in the absence of currents, density differences and atmospheric influences. Figure 3.1 shows an estimate of the mean (i.e. time averaged) SSTOP from a numerical model of the ocean. Amplitudes of approximately +/- 1 metre can be clearly identified in the areas of the major currents (Gulf Stream, Kuroshio, Antarctic Circumpolar Current etc.), and this signal can be seen to be two orders of magnitude smaller than that of the geoid (Figure 3.2).

The complete understanding of the difference between the MSS and the geoid surfaces, and thereby of the mean SSTOP and the mean surface circulation, is at present limited by imprecise knowledge of the geoid (i.e. of the Earth's gravity field). A satellite gravity mission is required to provide an independent measurement of the gravity field; several have been proposed in recent years [4] but none has so far been launched.

Studies of variability in surface circulation do not require knowledge of the geoid, which can be considered as essentially constant, but only of variations in SSTOP (or sea level) gradients. Such variations can be observed from precise altimetry and from pairs or networks of tide gauges. Examples are provided by the use of TOPEX/POSEIDON (T/P) altimeter data [5], the monitoring of flows through straits by tide gauge pairs [6,7], and the observations of El Niño-related tropical Pacific sea level variability by means of an extensive gauge network [8].

The lack of knowledge of the ocean circulation, and in particular of ocean heat fluxes, for long term climate change research has been documented by many study groups [9]. Altimetry and tide gauge data have provided complementary sea level data sets during the TOGA (Tropical Ocean Global Atmosphere) and WOCE (World Ocean Circulation Experiment) programmes of the last decade, and will supply ongoing sets of information for the CLIVAR (Climate Variability and Predictability) programme. As much of ocean variability consists of low frequency and large spatial-scale variations, emphasis has to be on the provision of long data sets with global coverage.

3.2 LONG TERM SEA LEVEL CHANGES

The longest tide gauge sea level records from around the world, all of which are available from the Permanent Service for Mean Sea Level (PSMSL, Section 8.1), indicate a rise of approximately 10-25 cm in global sea level during the last century, a large part of which may be accounted for by the climate changes which have occurred during this period [9]. Some long records are shown in Figure 3.3. Best-estimate predictions are for levels to rise by approximately 50 cm in the next century, within a wide range of uncertainty spanning 13-110 cm [9]. The need for long term monitoring of possible accelerations in rates of change of sea levels via a set of precise, globally distributed tide gauges is one of the main scientific justifications for GLOSS.

Tide gauges measure sea level relative to the level of the land upon which they are situated. Consequently, if land levels change, then "sea level" will also appear to change. Figure 3.4 shows records from north to south in western Europe, where the Stockholm record is dominated by post-glacial rebound (PGR) land movements which obscure any real changes in ocean level. The other records, from stations further south, have secular trends comparable to the global average.

PGR is the continuing readjustment of the Earth's crust since the glacial retreat at the end of the last ice age. It is the only globally coherent geological contribution to long term sea level change about which we possess detailed understanding. Geodynamic models of PGR, such as the Peltier ICE 3-G model [10], and various type of geological and archaeological data, have been used by a number of authors to correct tide gauge sea level trends for their land movement signals and to extract estimates of present-day eustatic (i.e. "real") sea level change.

Of course, there are other contributions to land movements in addition to PGR. These are usually lumped into the expression "tectonics" and in most cases they are local in extent; vertical movements associated with earthquakes are the most obvious example. In the last few years, modern geodetic techniques have become available which have allowed for the first time the measurement, as opposed to the modelling, of vertical movements [11,12,13]. The main technique is that of the Global Positioning System (GPS) while the use of absolute gravity measurements could provide important parallel data sets in some countries. GPS, absolute gravity and other such measurements have the advantage that they need not be employed solely at tide gauge sites. For example, they can be located in inland areas of maximum rates of PGR uplift, providing a comprehensive testing of the geodynamic models. The formation of the International GPS Service for Geodynamics (IGS) provides an organisational framework within which such GPS measurements at gauges and elsewhere can be made, with estimates of land movements at gauge sites eventually combined with the tide gauge data in order to provide a decoupling of land and ocean level signals in their records.

Since the launch of the T/P satellite in 1992, the community has had access to a radar altimeter system capable of providing sea surface height measurements of several-centimetre precision [14] i.e. fully capable of monitoring any several-decimetre sea level changes in the next few decades. For the first time, measurements of truly-global sea level changes have become possible with information on the ocean circulation fluctuations responsible for those changes inherently part of the data set. Moreover, in principle, altimeter measurements of global-average geocentric sea surface height should be free of complications due to land movements, whether from PGR or tectonics, and should correspond to change in ocean volume or "eustatic change". (In fact, small corrections can be applied to account for global-average geoid variations due to PGR). Preliminary estimates of the rate of global sea level change over the 3 years since launch were somewhat in excess of those obtained for the last century by tide gauges. These estimates are now known to have been incorrect, and several investigations of systematic errors have resulted in considerably lower values (Figure 3.5). However, in spite of this initial uncertainty, it is clear that precise altimetry is maturing into a developed technology, fully capable of contributing to a global sea level monitoring system. Therefore, a major challenge for GLOSS in future will be to make use of both the altimetry and tide gauge techniques in combination.

3.3 OPERATIONAL USES AND COASTAL ENGINEERING APPLICATIONS

For coastal operations and engineering design, sea levels are needed both in the form of instantaneous levels, but also in terms of the statistics of extreme levels over long periods. Immediate operations such as shipping movements demand accuracies of around 0.1 m, whereas long-term monitoring of sea level trends calls for accuracies of 0.01 m or better. In practice, there are advantages in making all observations to the higher accuracy, so that the data is available for all applications.

Short-term measurements, often with real-time data transmission, are needed for: ship movements in harbours and ports; for issuing storm surge and tsunami warnings; and for the operation of sluices and barrages.

Over a longer period, data are needed for: tidal analysis and prediction; for control of siltation and erosion; for inputs to models to estimate the paths of pollutants and to forecast water quality; and for the design of reclamation schemes and the construction of disposal sites. They have uses also in studies of upwelling and fisheries in tropical areas.

Statistics of sea level variability are needed to calculate probabilities of extremes in the design of sea defences, and for engineering related to port design and dredging works. Historically, many national datum levels for land surveys are based on measurements of mean sea level over some defined period. These levels are often used to define state and national boundaries, for example as specified in the United Nations Convention on the Law of the Sea. Low water levels are used as the datum for tidal predictions and for the datum level in hydrographic charts.

Long-term changes of sea levels and the statistics of extremes are also monitored to compute changing risks of flooding for insurance and design purposes. They may also be used to indicate potential earthquake activity and salt water intrusion into aquifers used for freshwater abstraction.

In many of these applications the rapid exchange of reliable data, nationally, regionally and even globally, can increase the value of the predictions. This exchange of data and operational experiences is something which GLOSS can actively support and encourage.

The importance of sea level measurements for national and regional scientific research and for many practical applications has been emphasised within a number of regional oceanographic programmes coordinated by IOC. GLOSS itself has stimulated the development of proposals for regional networks, and associated oceanographic programmes, in several parts of the world, e.g. European coast, Mediterranean, Caribbean, Indian Ocean, Southern Ocean (Chapters 8 and 9).

4. STATED AND IMPLIED REQUIREMENTS FOR SEA LEVEL MONITORING FROM OCEAN AND CLIMATE STUDY GROUPS AND RESEARCH PROGRAMMES

A number of research programmes and scientific study groups have made cases for various types of sea level measurements within a global sea level observing system. Several of these are summarised below, together with a general case for sea level studies within national and regional activities. GLOSS will work as closely as possible with all bodies in order to provide suitable sea level information.

4.1 INTERGOVERNMENTAL PANEL ON CLIMATE CHANGE (IPCC)

The Intergovernmental Panel on Climate Change (IPCC) operates under the auspices of the World Meteorological Organisation (WMO) and the United Nations Environment Programme (UNEP). The IPCC's First Assessment Report was completed in August 1990. It confirmed the scientific basis for climate change, and served as the basis for negotiating the UN Framework Convention on Climate Change. The second scientific assessment have been conducted by IPCC in 1995 and Chapter 7 (Changes in Sea Level) of its Report [9] provides the most recent, comprehensive review of the evidence for global sea level change during the last century, and makes predictions for potential change in the next. It also stresses the need for a global sea level monitoring system with components similar to those outlined in this Plan, and with information from the many sources integrated and distributed as useful products. Similar recommendations have been made by a number of other working groups concerned with sea level and climate [15].

4.2 WORLD CLIMATE RESEARCH PROGRAMME (WCRP)

The World Climate Research Programme (WCRP) is a joint undertaking of the International Council of Scientific Unions (ICSU), WMO and IOC. The scientific guidance for the conduct of the WCRP is provided by a Joint ICSU-WMO-IOC Scientific Committee (JSC). The need for a global sea level observing system was recognized in the First WCRP Implementation Plan as far back as 1985 [16] and sea level appears in several other WCRP projects than those discussed here (e.g. GEWEX, which is concerned with the global hydrological cycle).

4.2.1 The Tropical Ocean Global Atmosphere Programme (TOGA)

The TOGA programme, which spanned the decade 1985-95, was one of the first key projects within the WCRP. Although TOGA itself has now formally ended, we refer to it here as its science continues in CLIVAR (see below), its importance to GLOSS development cannot be underestimated, and it continues to provide an excellent example for other GLOSS regional activities (Chapter 9). The main aim was to develop a description of the tropical oceans and the global atmosphere as a time dependent system. The extent to which this aim has been met can be gauged from the many advances in tropical research which have taken place in the decade [17].

A key component of TOGA was the maintenance and development of the Pacific tide gauge network installed by K. Wyrski and colleagues at the University of Hawaii (UH) as part of the North Pacific Experiment (NORPAX). This network was subsequently enhanced by installations in the Indian Ocean and, to a lesser extent because of the scarcity of islands, the Atlantic Ocean. Data from many of the gauges, including most of the island gauges operated by UH, were transmitted to the TOGA Sea Level Center in Hawaii via satellite, while delayed mode processing was applied to other data sets. Many of the TOGA tide gauges contributed to the Integrated Global Ocean Services System (IGOSS) [18] Sea Level Programme in the Pacific and to "fast centre" WOCE operations. Figure 4.1 shows the coverage of sea level data obtained in TOGA; further scientific and technical details can be obtained from the literature [17,19].

In many ways, the sea level component of TOGA was a precursor of GLOSS. The requirement for TOGA gauges typically 500 km apart was also included in GLOSS selection criteria ([1] and Section 5.1).

Also, as with GLOSS itself, sea level research within the project during the past decade was influenced considerably by developments in altimetry.

4.2.2 The World Ocean Circulation Experiment (WOCE)

The World Ocean Circulation Experiment (WOCE) is the principal activity within "Stream 3" of the WCRP [20,21]. The field phase of WOCE has been in progress during 1990-1997 while an analysis and synthesis phase will continue to 2002.

WOCE has two major goals:

Goal 1: To develop models useful for predicting climate changes and to collect the data necessary to test them, and

Goal 2: To determine the representativeness of the specific WOCE data sets for the long term behaviour of the ocean, and to find methods for determining long term changes in ocean circulation.

The acquisition of sea level data has been important for both goals. For example, in goal 1, sea level data from pairs of gauges across straits have been used to estimate transport fluctuations for input to numerical ocean models. The historical sea level data set of the PSMSL has been relevant to goal 2, in determining representativeness of sea level information during WOCE, while the analysis of sea level data at Antarctic tide gauge sites has suggested the feasibility of their use in constructing indices of Antarctic Circumpolar Current flows. (Chapter 5 provides further details of each of these topics). Tide gauge data have also been used extensively and successfully as *in-situ* comparison tests of altimetric sea surface heights obtained from T/P and the ERS satellites [22].

At the commencement of WOCE, the programme's Scientific Steering Group agreed to the proposal that approximately 70 gauges be designated as the "WOCE Sea Level Network" which consisted in large part of the island subset of GLOSS together with a number of gauge-pairs across straits. Two WOCE Sea Level Data Assembly Centres (DACs) were established at UH Sea Level Center (UHSLC, the so-called "fast centre") and at the British Oceanographic Data Centre (BODC, the so-called "delayed mode centre", alongside the PSMSL). The fast centre was charged with the provision to the WOCE community of as large and quality controlled a data set as possible of raw (i.e. typically hourly) gauge data within approximately 2 months (which at that time was considered to be the timescale for altimeter data processing). The delayed mode centre was charged with providing a more complete, fully quality controlled product at the end of the WOCE field phase (Figure 4.2).

Some of the argumentation for tide gauge data collection during WOCE has now been overtaken by scientific developments (e.g. the stated need for gauge data for altimeter orbit error reduction in the 1990 GLOSS Plan). On the other hand, WOCE gauge data have proved to be essential to altimeter bias calibration (Chapter 5). This is a good example of fundamental data sets remaining invaluable, even though their detailed applications may change during a programme. Experience in operating the two centres with overlapping and complementary responsibilities has been very fruitful with regard to future GLOSS data flow arrangements (Chapter 7).

4.2.3 The Climate Variability and Predictability Programme (CLIVAR)

CLIVAR (Climate Variability and Predictability) is the main interdisciplinary research effort within the WCRP for exploring climate variations on timescales of months to a century or longer. CLIVAR will exploit the "memory" in the slowly changing oceans and develop understanding of interactions between the atmosphere, land, oceans and cryosphere as they respond to natural processes, human influences and changes in the Earth's chemistry and biota.

The CLIVAR Science Plan [23] includes only a short section on the importance of sea level measurements within climate monitoring, recognizing the role of altimetry and the symbiosis between tide

gauge and altimetric data. In 1996, a US Ocean-CLIVAR study report [24] made more detailed recommendations for future sea level monitoring recognising the complementarity of satellite altimetry and geodetically-controlled tide gauges including the potential for gauges to provide altimeter calibration; the need for ongoing and overlapping altimeter missions; and the central role provided by the International Earth Rotation Service (IERS).

4.2.4 The Ocean Observation Panel for Climate (OOPC)

The Ocean Observation Panel for Climate (OOPC) is a panel sponsored jointly by the WCRP, the Global Ocean Observing System (GOOS) and the Global Climate Observing System (GCOS). It is charged with providing scientific input to the implementation of ocean observing, following on from the final report of its predecessor panel the Ocean Observing System Development Panel (OOSDP) [25]. The OOSDP report recommended a continuing subset of GLOSS with long records and with many sites geodetically-controlled; precise altimetry; a subset of the TOGA tide gauge network until altimetry becomes routine; island gauges for altimeter calibration; and a space gravity mission.

The OOPC itself has noted [26] that altimetry and *in-situ* sea level in combination offer a product that retains the benefits of both the long *in situ* records and the global coverage of the altimeter, in effect giving useful global estimates of long term change at large space scales. Implications are the need for a set of near-real time reporting tide gauges each of which is geocentrically located (Section 5.1.3). The OOPC has commissioned a report to determine the optimal *in situ* network in support of such a goal.

4.3 THE GLOBAL OCEAN OBSERVING SYSTEM (GOOS)

GOOS is a new, internationally organised system for the gathering, coordination, quality control, distribution and generation of derived products of all kinds of marine and oceanographic data of world-wide importance. It is a concept similar to the global meteorological observing network, World Weather Watch, supported by national governments and implemented through the contributions of national agencies, organisations and industries, with the assistance of national and international data management and distribution bodies. The guiding principle is that great benefit can flow in the use and protection of the world oceans, in global weather and climate prediction, and in reducing natural disasters, through increased and continuous availability of systematic marine observations obtained and organised through a global network.

The need for a GOOS was identified by the IOC in 1989 and supported by the WMO Executive Council. The establishment of a GOOS was also urged by the Second World Climate Conference in 1990, in order to provide the oceanographic data needed by the proposed Global Climate Observing System (GCOS), which was initiated by WMO, IOC, UNEP, and ICSU in 1992. That same year, the United Nations Conference on Environment and Development (UNCED) called for States to support the development of a GOOS to improve rational use and development of coastal areas, all seas and marine resources. Their recommendation is published in UNCED's Agenda 21. The Intergovernmental Committee for GOOS (I-GOOS), sponsored by IOC, WMO and UNEP was established by the XXV Session of the IOC Executive Council in March 1992 to meet these demands, along with a Scientific and Technical Advisory Committee (J-GOOS), sponsored by IOC, WMO, UNEP and ICSU, to provide the design of GOOS. I-GOOS first met in February 1993, and J-GOOS in May 1994. J-GOOS will be absorbed into a new GOOS Steering Committee (GSC) at the end of 1997.

In the planning phase the design of GOOS is being considered in terms of 5 modules, each representing either a major user sector, or a "cross-cutting" activity:

1. Climate Monitoring, Assessment and Prediction. This module provides the ocean component of GCOS. The lead is being taken by the Ocean Observing Panel on Climate (OOPC) (section 4.2.4).
2. Monitoring and Assessment of Living Marine Resources.
3. Monitoring of the Coastal Environment and its Changes.
4. Assessment and Prediction of the Health of the Ocean.
5. Marine Meteorological and Oceanographic Services.

GLOSS will contribute to several GOOS modules, particularly the Climate and Coastal modules as well as the Operational Services module. The requirements of the different GOOS modules for sea level observations, including network density, accuracy, time and space resolution, transmission of data, are likely to be different. As those requirements are defined they will be taken into account, along with achievements in technology and numerical ocean and climate models, by the GLOSS Group of Experts when considering GLOSS developments.

The contribution of GLOSS measurements of sea level to the Climate Module of GOOS is self evident in the context of using changes in sea level to monitor the effects of climate change. GLOSS measurements of sea level are also important to the Coastal Module of GOOS, where the measurements of absolute and relative change in water level are essential for assessing the dangers of flooding from subsidence or storm surge. GLOSS sea level measurements are also important for the Health of the Ocean Module of GOOS, for assessing the effect of tidal streams on the dispersal of contaminants such as spilled oil. To make the data really useful, what is needed is a real-time communication network. GLOSS and GOOS are complementary, with global, regional, and local components. Similarly, both are cross-cutting, treating the needs of communities interested in both climate, coasts and ocean health. GLOSS will therefore be essential for the success of GOOS in the short and long term.

One important objective of GOOS is to facilitate the means by which less developed nations can increase their capacity to acquire and use marine data. Special attention will be given to training, education and mutual assistance efforts and technology transfer. In developing this capacity building component of GOOS the experience of GLOSS in training and technology transfer (Chapter 10) will be of great value.

4.4 THE INTERNATIONAL GEOSPHERE-BIOSPHERE PROGRAMME (IGBP)

The International Geosphere-Biosphere Programme (IGBP) is a research programme operated under the auspices of ICSU. In 1995, the IGBP published the Implementation Plan for the Land-Ocean Interactions in the Coastal Zone (LOICZ) programme [27]. The Plan focuses on processes which affect the coastal zone, with particular reference to the commercial, residential and environmental infrastructures which depend upon it. Framework Activity 6 of the Plan is entitled "Determination of the Rates, Causes and Impacts of Sea Level Change". This activity concerns the study of local, relative (rather than global, geocentric) sea level changes and their consequences, and has been constructed in consultation with geodesists in view of the equal importance of land level changes (i.e. submergence) to relative change. There are as yet no specific recommendations with regard to sea level observing, although the LOICZ studies will clearly benefit from and overlap with those of other programmes.

4.5 THE INTERNATIONAL LITHOSPHERE PROGRAMME (ILP)

The International Lithosphere Programme (ILP) was instituted in 1980 as the successor to the International Geodynamics Project. It seeks to elucidate the nature, dynamics, origin and evolution of the lithosphere, with special attention to the continents and their margins. The ILP is guided by the Inter-Union Commission on the Lithosphere, established by ICSU at the request of the IUGG and the International Union of Geological Sciences (IUGS). The programme includes a special theme on Space Geodesy and Global Sea Level. While the programme benefits from global sea level recording, no specific recommendations have been made regarding networks.

4.6 REQUIREMENTS WITHIN REGIONAL AND NATIONAL ACTIVITIES

The previous chapter listed the many practical applications for sea level data within national and regional activities. Clearly, not all of these applications can be addressed by means of the designated GLOSS gauges alone. GLOSS will serve as a strategic global network around which national and regional networks may be constructed, thereby densifying the spatial coverage of sea level measurements as required.

GLOSS is an important part of IOC's contribution to the UN Small Island Developing States (SIDS). The Action Programme adopted in Barbados, 1994, emphasizes the importance of sea level in relation to climate change and development problems under SIDS.

Of course, many countries have considerable experience in making sea level measurements. However, one often finds that a country has developed its own measurement methods and data analysis practices almost in isolation. One of the benefits of an existing global network (GLOSS) to such activities is in the definition, and evolution, of standards. GLOSS has already played a major role in the provision of training materials for tide gauge operations, with the aim of obtaining the most precise sea level (in practice sub-centimetre accuracy) data possible. In addition, GLOSS, together with the International Association for the Physical Sciences of the Ocean (IAPSO) and other interested bodies, has stimulated international discussion of best methods of application of the new geodetic techniques for geocentric locating of tide gauge benchmarks. It is essential that such continually-updated expertise on methods and standards is available within a global context, to be referenced as required by national authorities and by the developers of regional networks.

5. THE GLOBAL SEA LEVEL OBSERVING SYSTEM (GLOSS): PRESENT AND FUTURE

A Global Sea Level Observing System (GLOSS) for the twenty-first century must include the following elements:

1. A global tide gauge network, qualitatively similar to that of the 1990 Plan, but with coverage refined as necessary. Part of this network, designated the GLOSS-LTT subset, must be capable of provision of data sets for studies of long term sea level trends and accelerations;
2. GPS monitoring of tide gauge benchmarks at as large a set of gauges as practical such that the land and ocean level change components of long tide gauge records might be separable within 10-20 years;
3. Within (1) and (2), a network of gauges, based largely on islands and fully equipped with GPS geodetic control, which will be a special subset of (1), for the purpose of ongoing calibration of the altimeters in (5). This subset is designated GLOSS-ALT.
4. Also within (1) and (2), a network of gauges required to provide ongoing monitoring of aspects of the global ocean circulation. This subset is designated GLOSS-OC.
5. Ongoing altimetric coverage of the global ocean by means of missions of T/P standard or better;
6. For the gauges in (1), the provision of a modern system of data acquisition and data flow to international centres such that data sets are provided in timely fashion as required, are subject to best possible quality control, are shared between centres and distributed to scientists by fully electronic means, and are archived in the most reliable long term manner;
7. The provision of sets of training materials on data acquisition and analysis (tide gauge, altimeter and GPS), which are as complete as possible, which are published in both paper and electronic forms for the widest possible distribution, and which are complemented as far as possible by formal training courses in different countries;
8. A programme of regional activities which will serve to effectively extend and enhance GLOSS global research.

In addition, GLOSS, together with related bodies such as IAPSO, should take the responsibilities as far as possible for:

9. The maintenance of an overview of technical and scientific developments in sea level change and related fields; and
10. The encouragement wherever appropriate of research into the understanding of sea level changes on various timescales (e.g. model developments of various kinds) and the practical applications of sea level data.

Elements 9 and 10 would be served by, for example, participation of related scientific and user representatives in the GLOSS Group of Experts, in GLOSS training courses and in GLOSS-related scientific meetings.

The provision of these elements is described in the following three sections which are concerned with tide gauges, geodetic control, and satellite radar altimetry.

5.1 GLOSS TIDE GAUGES

5.1.1 Present Status of "GLOSS 93"

The 1990 Plan defined GLOSS in terms of a network of 306 tide gauges distributed around the world. The criteria for site selection within the network were:

- (i) a gauge was allocated to each ocean island or group of ocean islands at intervals not closer than 500 km;
- (ii) gauges were included along continental coasts at intervals generally not less than 1000 km, preference being given to nearshore islands to maximise the exposure to the open ocean;
- (iii) in special cases, such as a strait that connects large parts of the oceans, the network density was increased so that a minimum of one gauge on either side of the strait was included; and
- (iv) priority was given to well established gauges, and gauges which have a long history of previous operation, since these can give valuable information on sea level trends and accelerations.

The intention was to provide a data set that admittedly omitted many established gauges, especially from the northern hemisphere, and which contained only a small number of stations from regional seas (Mediterranean, Baltic etc.). Nevertheless, the network would be the first attempt at obtaining a coordinated sampling of global sea level variations from a geographically-representative set of stations.

The network (GLOSS 90) was redefined slightly in 1993 following submissions from several countries on the suitability of certain gauges from operational or oceanographic perspectives. The new network definition (GLOSS 93) contained 308 stations.

In addition to the establishment of the network itself, one of the main objectives for GLOSS was for each gauge to report monthly mean sea level (MSL) values to the PSMSL in a timely manner. Consequently, each year since 1989, the PSMSL has provided a summary of the status of GLOSS from its viewpoint. The summary has usually been made in October so as not to bias the statistics because of the seasonal cycle of data receipts.

An "operational" station from a PSMSL viewpoint means that recent MSL monthly and annual values have been received by the Service, have been checked as far as possible, and have been included in the databank. For each of the GLOSS stations, the PSMSL uses the year of the last data entered into the databank (Annex II), if any, to place the station into one of four categories:

- Category 1: "Operational" stations for which the latest data is 1992 or later;
- Category 2: "Probably operational" stations for which the latest data is within the period 1982-1991;
- Category 3: "Historical" stations for which the latest data is earlier than 1982;
- Category 4: For which no PSMSL data exist.

As of October 1996, the number of stations which fall into Categories 1 to 4 are 186, 46, 21 and 55 respectively (Figure 5.1). As regards the subset of stations which were "committed to GLOSS" in the 1990 Plan, the numbers are 156, 34, 9 and 18 respectively. "Committed to GLOSS" means that formal commitments were made in 1990 by national authorities to IOC to keep gauges operational (Chapter 12). Figure 5.2 presents an overview of the subdivision into Categories, showing also the corresponding numbers from previous years with the category definitions adjusted backwards one, two, three etc. years appropriately. (Note that before 1993 GLOSS was defined by "GLOSS 90" which contained 2 stations less than "GLOSS 93").

It can be seen that there has been a gradual but significant improvement in the status of GLOSS through the years, as gauges installed for WOCE, TOGA etc. have begun to contribute to the network and

to provide data to the PSMSL. Figure 5.1 shows that most of the sites remaining in Category 4 are in remote locations where installations can present formidable problems.

In fact, the status of GLOSS is even better than implied by Figures 5.1 and 5.2. In a review carried out for the GLOSS Group of Experts in February 1995 [28], it was determined that only 54 GLOSS sites have no working gauge at all, i.e. 254 are operational. This is a larger number than that of the Category 1 stations in Figure 5.1 for two general reasons:

- (i) some gauges, concentrated especially in polar areas, are composed of simple pressure transducer sensors which provide important time series of sub-surface pressure for oceanographic studies, but not MSL values which can be transmitted to the PSMSL. In order to compute sea level from pressure sensor data, one needs to apply corrections for atmospheric pressure, water density and local acceleration due to gravity, and relate the computed sea level values to a land datum. It has long been realised by GLOSS that some gauges, especially those in extreme polar areas, will not be able to provide MSL data in the same way as gauges at lower latitudes. Nevertheless, their data are important and several workshops have been devoted to this topic [29,30,31]; and
- (ii) there are limitations on the supply of MSL (and other) data imposed by financial or political constraints, by problems of effective communication or by requirements for training.

The operational and non-operational stations are indicated in Annex IV and Figure 5.3 which should be regarded as the best overview of the status of the core network as defined by GLOSS 93.

Information on the status of recording at each GLOSS site, including gauge types and site maps, is contained in the "GLOSS Station Handbook", a CD-ROM product produced by the BODC and PSMSL in 1996 (Annex VI).

5.1.2 Future Use of Tide Gauges in GLOSS

Even in an age of continually-improving altimetry, tide gauges continue to possess important attributes for measuring sea level changes including continuity with historic measurements; high accuracy; continuous sampling; ability to record at the coast where people live; ability to operate in ice-covered areas; and relatively low cost.

We propose that most of the existing tide gauge components of GLOSS continue into the next decade essentially unchanged, until the new technologies (altimetry, GPS etc.) have become firmly established, when the status of recording will be reviewed once again. However, there must be important changes of emphasis from the 1990 Plan as follows:

(i) *The GLOSS Strategic Core Network*

A future GLOSS core network will be based on the criteria established in the 1990 Plan, but the number of sites will be reduced as effective duplicates are removed along with stations which experience has shown will be impossible to instrument. Other sites will continue to be replaced by neighbouring alternatives if they can be demonstrated to be clearly superior for operational and oceanographic reasons. A small number of stations may be added to the network if they are of clear benefit to GLOSS overall.

The reduced number of sites within this strategic core network will continue to satisfy the general requirement for a representative sampling of sea level variability along the world's coastlines proposed in the 1990 Plan. If one sums the numbers of gauges implied by the various separate requirements for monitoring in Chapters 3 and 4, then a total number insufficiently different to that of the core network to be controversial emerges. Discussion as to whether the global network should contain, say, 200 rather than 250 sites is an esoteric one, if many of the other 50 are anyway required for regional networks, which to date we have considered as "extensions to GLOSS" rather than "GLOSS" itself.

From a "cultural" rather than "scientific" viewpoint, the order of 200-250 sites is also large enough to attempt to stimulate effective participation in GLOSS by a large number of countries, which is an important consideration with regard to the IOC Training, Education and Mutual Assistance (TEMA) programme.

The first major revision of the core network since GLOSS 93 took place in March 1997 based on sets of correspondence throughout 1996-97 following the review of [28]. This revision has resulted in the removal of 21 sites (none were added), with the agreement of relevant Member States, resulting in a GLOSS 97 definition of the core network (Annex IV and Figure 5.4). This selection will be employed within GLOSS activities in the near future (e.g. in the production of a new GLOSS Handbook CD-ROM), and it is anticipated that a further review will take place during 1998.

(ii) *Long Record Sites (whether in core network or not)*

The selection criteria for GLOSS in the 1990 Plan can be seen, in practice at the present time, to provide a sampling primarily for ocean variability studies, rather than for the long term climate change studies of IPCC, IGBP etc. (Chapter 4). Of course, as time progresses, GLOSS MSL records might be expected to lengthen and to provide a suitable geographically-representative spatial sampling for secular trend studies. However, as typically 40-50 years are required to determine an accurate trend ([32], and consider Figure 3.3), many of the GLOSS records will be unsuitable for that application for many years.

At present, the majority of the scientifically useful records for trend studies are along the northern hemisphere coastline and are under-sampled by the GLOSS site selection criteria. For example, many of the longest and highest quality records are in the Baltic, an inland sea largely omitted from GLOSS 93. One might argue that these stations should be included in regional GLOSS networks, but not all regions are undertaking such activities.

Virtually any good-quality station with a record several decades long is of potential value for long term sea level studies. In addition, the scientific case for providing GPS monitoring at, say, the Stockholm gauge (the station with the longest, continuous record in the world still operational) is as strong as the case at any GLOSS site (Element 2 above). Consequently, these stations should be recognized as forming a relatively more important role within global sea level observing ("GLOSS" in a general sense) than might have been implied by the 1990 Plan.

The consequences of this clearly-stated recognition are very important:

- a) National authorities with gauges with long, high quality records should be assured by GLOSS that these records are indeed of great scientific importance and should be continued;
- b) GLOSS standards for tide gauge operating should be adopted for these gauges as well as for the designated GLOSS stations in the core network;
- c) Monthly and annual MSL values should continue to be sent to the PSMSL with original (hourly or similar) data also made available as described in Chapter 7; and
- d) Authorities should be encouraged to collaborate with IOC on all aspects of GLOSS (workshops, training etc.). It has been anomalous that so far some countries with long, important records (e.g. the Netherlands) have not taken full part in GLOSS discussions because their stations have been excluded from the network by the 1990 Plan criteria.

(iii) *Regional GLOSS Networks*

As discussed in Chapters 3 and 4, the GLOSS strategic core network has been complemented by the definition of regional sets of gauges in several parts of the world, providing an extension and local densification of GLOSS 93. Although arrangements may differ in each case, one would envisage in future each regional activity having its own methods of coordination, local workshops and products, and its

International Centre (Chapter 7), in addition to representation within the GLOSS Group of Experts. Regional activities can be expected to expand. For example, see discussion of Mediterranean and Indian Ocean activities in Chapter 9.

5.1.3 Priorities for GLOSS Installations

The previous section has indicated potential interest from GLOSS in a large number of tide gauge stations: the core network, long record sites and regional networks. All of these are important. However, it is essential that GLOSS indicates which have relatively greater interest, and therefore higher priority for installation and maintenance, especially with regard to the "global" aspects of the programme.

Three overlapping subsets of the GLOSS gauge network (GLOSS-LTT, GLOSS-ALT and GLOSS-OC) have been identified as being of special interest with regard to ongoing studies of long term sea level trends, altimeter calibration and ocean circulation respectively.

Of course, the provision of these subsets in this Plan should **not** be interpreted as a recommendation by GLOSS that recording at other sites is less important overall. For example, one would obviously not recommend that measurements be given low priority or abandoned at a good, existing site in order to install another gauge at a remote and difficult location. In our experience, such priority clashes seldom occur in practice.

(i) *GLOSS-LTT: Tide Gauges for Long Term Sea Level Trends*

Section 5.1.2 stressed the fact that many well-maintained long record tide gauge sites have the potential to contribute to long term sea level change studies. In such investigations at present, records of typically 40-60 years or longer are employed to establish reliable trends with a "statistical" error lower than about 0.5 mm/year. Estimates of rates of vertical land movements are then subtracted from the observed trends in order to provide a determination of "real" sea level change. In most analyses, this subtraction is performed by means of a model of present-day vertical land movements arising from post-glacial rebound (PGR) [9]. This necessitates an intelligent filtering of the tide gauge sites in order to select locations which are "far field" from areas of maximum rebound (i.e. far from Scandinavia and northern Canada) and which are not subject to other major, unmodelable geological processes. See [32] for an excellent example.

The advent of GPS can radically modify this approach. Accurate rates of vertical land movements can be measured in a decade or so by GPS, rather than simply modelled (Section 6.2). Consequently, data can be used for trend studies from all gauge sites equipped with GPS, including Scandinavia (with its many fine, long gauge records) and even earthquake-prone areas. Therefore, the potential for wider global sampling of reliable long term trends than in [32] will be much improved.

In the medium term (i.e. approximately the next 10-20 years), the maximum benefit will be derived from the deployment of GPS at sites with existing tide gauge records several decades or longer, rather than at entirely new sites [12]. If rates of vertical land movement prove to be essentially linear, they may be applied with confidence to the historical gauge record. At sites which prove to be not linear, the benefits of such investment in terms of obtaining more spatially-representative trends will clearly take longer to be realised, although with geophysical insight it is feasible that studies may provide acceptable limits to real sea level trends over reasonable periods.

Figures 5.5a,b shows gauge locations with at least 40 or 60 years of data respectively in the Revised Local Reference set of the PSMSL (Section 8.1). Clearly, many of the non-GLOSS sites within this subset can provide as good data for trend studies as the official GLOSS locations. In general, priority site selection for gauge upgrades or GPS receiver installation is best studied within national or regional working groups. (Several examples are discussed in Chapters 8 and 9). Nevertheless, the fact that a site is a designated GLOSS core network station is of importance as the country concerned will have nominated it to be part of GLOSS and will have formally undertaken to maintain it as well as possible (Chapter 12).

Consequently, appropriate criteria for priority long term sea level monitoring sites in the medium term would be:

- a) sites with long records of, say, 60 or more years of RLR data, whether formally GLOSS or not. In practice, this selects many of the long record sites from Scandinavia, Mediterranean and North America which are not GLOSS (Figure 5.5b). If one is interested in "accelerations" rather than "trends", then an even greater weight should be given to these longer record sites [33,34]. Almost all of these will eventually be upgraded with GPS by geodetically-advanced countries; and
- b) sites with acceptably long records of, say, 40 years or more which are in the GLOSS core network and which, therefore, may also be of interest for other oceanographic purposes and which, on average, are likely to be well maintained.

Annex IV lists higher priority sites in this subset which has been designated GLOSS-LTT. Figure 5.6 shows their locations, while the GLOSS Station Handbook (Annex VI) provides more detailed information on the gauge at each site.

Each station's benchmarks should eventually be monitored by GPS. Although impressive starts to GPS monitoring have been made in some areas [13], measurements are still far from comprehensive throughout the LTT set. However, as the costs of receivers and data processing fall, it may become possible to monitor many such sites. Consequently, the existence, or not, or a receiver at a gauge at present is not a good guide to what may be both desirable and feasible in the near future.

Clearly, the list can be made more geographically-representative by the selection of sites with shorter records from regions with lower recording density. Suggested GLOSS sites with medium length records (i.e. typically 20-30 years) from Brazil, Africa, western Indian Ocean and Antarctica are also included in Annex IV and Figure 5.6. Annex IV can also be extended eventually by means of "data archaeology and rehabilitation" reanalyses of historic data (Section 7.4).

Conversely, the list could be pruned and optimised in data-rich areas if it could be demonstrated that "real" sea level change was coherent between stations, that differential relative sea level change was determined by vertical land movements, and that GPS would provide the future land movement information. However, this ideal situation pertains primarily in Scandinavia and the east coast of the USA, areas for which most of the long record sites are likely to remain in operation.

The list could, in principle, be optimised further by using circulation models as a guide to areas where larger rates of rise of sea level might be expected in future. For example, the NE Atlantic has been suggested as one region where greater than average rates of rise might be anticipated [35]. However, in practice, such models are still at the early stage of development for reliable regional forecasting [9].

In the longer term (i.e. > 20 years), one has to work towards greater geographical representativeness of the long term trend measurements, a requirement which returns us to the original motivation for the GLOSS core network. Within that wider set, it is difficult to define "higher priority" sites. For example, one might choose to nominate island sites for their open ocean character (and much publicised potential threat to low-lying countries); high latitude and polar sites for their range of PGR-related signals; locations where ocean models suggest greater than average potential sea level rise [9]; or sites along continental coastlines near to areas of human or environmental concern. As many nations will contribute to GLOSS development through national resources, it is not unrealistic to expect the GLOSS core network to form the basis of a more representative data set for trends in coming decades.

(ii) *GLOSS-ALT: Tide Gauges for Altimeter Calibration*

The success of TOPEX/POSEIDON (T/P) in demonstrating large spatial scale, low frequency variability in the ocean has underlined the need for an ongoing series of altimetric missions to study such

processes further, and eventually to compile time series of truly-global sea level change. In turn, this requirement stresses the need for a precise and effective means of calibration of each mission.

Altimetric sea surface height calibrations can take several different forms:

- a) "absolute" calibrations of altimeter range bias and drift at dedicated sites such as Bermuda (for Seasat), Harvest and Lampedusa (T/P), Venice Tower (ERS-1), Newhaven/Herstmonceux (T/P and ERS-1/2) which have a tide gauge, the data from which are located in the same geodetic reference frame as the altimeter data by means of laser ranging and GPS connections between laser and gauge;
- b) "relative" calibrations between heights of the same part of the sea surface obtained by two or more satellites operating simultaneously. Crossover data are employed in this role (e.g. between T/P and ERS-1) with a maximum time-difference selection imposed between crossovers (e.g. 5 days). Crossover information from the whole globe may be employed in this method in order to study possible regional dependence of the calibrations;
- c) "relative" calibrations between different parts of the same long mission, or between missions which may be many years apart, by means of an *in-situ* reference level, the height of which is monitored over the long term. In this case, the only altimeter data which are employed are those near to the reference site. Reference levels which have been investigated include land or ice surfaces such as flat desert terrain or ice sheets, the levels of which might be monitored by means of GPS; radar transponders [36]; GPS-buoys [37,38]; and a subset of the global tide gauge network. Tide gauges appear to provide some of the most suitable reference levels [22].

Tide gauges have the capability to contribute to both "absolute" and "relative" calibrations. An early example of an absolute calibration of T/P altimeter bias made use of the Herstmonceux laser ranger in the UK which was geodetically connected to the nearby Newhaven tide gauge by GPS. Altimeter heights off-shore of Newhaven were compared to geocentrically-located sea levels from the gauge, and numerical models were used to provide small corrections in tide, surge and geoid between the satellite nadir-point and the gauge. This, and similar work by other groups, suggested that the TOPEX altimeter was making range measurements approximately 17 cm too short. Similar time series of altimeter bias were made available for ERS-1 and -2 [39].

A graphic example of the use of gauge data to provide an ongoing check of T/P's range drift (i.e. a "relative" calibration) is shown in Figure 5.7 [40]. The data points show average values of altimetric minus tide gauge sea levels (to within an overall constant) for areas of ocean near to gauges in the "fast" WOCE set. A gradual rise of 2-3 cm can be seen during the 130 cycles of the mission (one cycle is 10 days), which analysis has subsequently shown to be due to an algorithm error in the software used to compute T/P altimeter range. The solid line in Figure 5.7 simulates the contribution of this error. The error was responsible for the unrealistically large global sea level rise reported by some T/P authors for the first few years of the mission, for a disagreement in absolute bias between the TOPEX and POSEIDON altimeters, and for the absolute bias reported by [39] and others being about 17 cm rather than approximately zero.

It is clear that gauges from selected sites can indeed be used to provide precise, ongoing and relatively low cost calibrations to altimeter missions. The relevant questions are: "How many gauges are needed for this application?", "Which ones?" and "Are special arrangements required?"

There are only a small number of groups involved in "absolute calibrations" in the UK, Japan, Australia, France and the USA. Their gauge data can be easily collected by a data centre.

Criteria for gauge selection for "relative calibrations" similar to that of Figure 5.7 include:

- a) low residual variance between altimeter and tide gauge time series i.e. gauges should be selected from sites with records which represent the variability of the nearby deep ocean. This would rule out many continental coastline sites in favour of islands, but would also exclude islands with large amounts of wind/wave setup;
- b) a reasonable geographic coverage. Tropical sites offer advantages over higher latitude stations with regard to (a), but it is important to note that most of the altimeter-tide gauge differences can be interpreted as being largely due to altimeter errors. These errors can have large correlation scales; e.g. a fractional error in the wet tropospheric correction, which is presently a suspect in the remaining drift estimated from the tide gauges for the T/P data, will be maximum at the equator and minimum at high latitudes. Thus the tide gauges must span this range in order to provide a reasonable global estimate of the error. The ability of the global tide gauge data set to provide more geographically-representative sampling has advantages over gauges from restricted areas (e.g. the Great Lakes [41]), although of course different data sets can provide valuable complementary information. (In addition, the possibility of residual geographically-correlated orbit error indicates the necessity for as near-global coverage as possible);
- c) provision of GPS and Doppler Orbitography and Radiopositioning Integrated by Satellite (DORIS) monitoring of the tide gauge benchmarks in order to supply ongoing geocentric-fixing of the sea level measurements in the same reference frame as the altimeter data, and, longer term, to supply measurements of the rate of vertical land movement [13]. In addition to their role for geodetic control of the gauges, both GPS and DORIS will be used in future to track the satellites themselves, which should result in a geodetically-systematic set of measurements.

As all satellites will not have the same 10 day repeat ground track as T/P, or may not have a repeat track at all, a more general method than the repeat track analysis used for Figure 5.7 is necessary. Such software, based on the use of data from crossovers which are within an acceptable short distance of a gauge, has been verified to give virtually identical results as the repeat track method when applied to T/P data [42]. The same software can be used to inter-calibrate T/P to presently-operating ERS-2 or to any altimeter with any ground track many years in the future. In summary, it has been verified that techniques exist for providing ongoing calibration of altimeters, as long as an optimum set of gauges can be selected, if GPS/DORIS geodetic control can be established [13], and if the calibration network can be maintained in the long term.

A recent examination of the global tide gauge data set and the T/P data set has been used to examine the impact of criteria (a-c) on an estimate of the error of a calculation of the global sea level change rate [43]. This study found that about 30 sites that were evenly distributed (by an equal area criterion) over latitudes of 60N to 60S, and were supported by independent estimates of land motion that were accurate to about 10 mm/yr over a one year averaging period, were sufficient to obtain an accuracy of about 1 mm/yr after 3 years time. Over a decade of continuous application, the error would drop to about 0.2 mm/yr. To be safe, there should be sufficient redundancy that order 30 sites are available at all times.

Figure 5.8 and Annex IV provide a first selection of tide gauge stations suitable for this purpose derived from this study [43]. More detailed investigations may be needed (e.g. into the stability of the relative calibrations to any variations of the gauge set which take place occasionally as some gauges malfunction or are terminated; into considerations of GPS and DORIS joint-availability rather than just GPS alone; and into practical difficulties associated with particular sites), as indicated in [43]. However, we are confident that such a network, which has been designated GLOSS-ALT, can perform the ongoing altimeter calibration task as required.

The requirements for raw tide gauge data flow for GLOSS-ALT are similar to those for present "fast" WOCE; that sea level data are required in more timely a manner than from GLOSS stations in general. In this case, we suggest a maximum delay of one month. Requirements for GPS data flow were discussed at a recent GPS workshop [13] and may be satisfied by means of modest expansion of existing IGS data processing

arrangements. GLOSS-ALT should have a designated International Centre for tide gauge and related data (Chapter 7). Raw data with full quality-control (QC), monthly and annual MSL values, and information provided by the IGS on rates of vertical land movement will be archived both at the Centre and by the PSMSL.

(iii) *GLOSS-OC: Tide Gauges for Ocean Circulation Monitoring*

It is clear that the primary means of monitoring the global ocean circulation in future will be via sea surface height measurements from space by means of radar altimeter satellites of T/P standard or better. However, there will be circumstances in which gauges will be more advantageous for monitoring important aspects of the circulation.

This section provides a short-list of such suitable sites. The last time an exercise such as this was conducted was for the WOCE programme (Section 4.2.2) over a decade ago, before altimetry had achieved its present accuracy and operational efficiency.

Gauges will continue to have an important function for ocean circulation studies in at least the following areas:

- a) across narrow straits, where pairs of gauges not only provide superior temporal sampling but are located typically in constricted coastal areas not suitable for cross-strait altimetric measurements. Examples include Straits of Gibraltar [44], Indonesian Through-Flow straits [45,46,47], and the various Caribbean and Florida straits ([48] and see discussion of IOCARIBE in Section 9.3.1);
- b) across wider "straits" and "choke points", and across basin-sections through which measurements of transport variability are of particular interest, each of which can be monitored more efficiently with pairs of gauges. Examples are the choke points of the Antarctic Circumpolar Current (Drake Passage, South Africa - Antarctica, Amsterdam - Kerguelen-Heard Island, Australia - Antarctica) which have been studied in detail during WOCE [49,50,51,52]. Sections spanning other major current systems such as the Gulf Stream [53], Kuroshio [54] and NE and NW Atlantic straits are also important, while there will be continued interest in monitoring aspects of Tropical Pacific circulation with sets of gauges ([55,17] and see Section 8.3.2).
- c) along polar coastlines, especially that of Antarctica. In the Southern Ocean, winter ice coverage to approximately 60 S precludes all-year altimetry, but sea levels along the Antarctic coast are a potential index of ACC transport [51,56]. Longer term, gauge data may provide information on "Antarctic Circumpolar Waves" [57]. The need for better tidal constituents from tide gauges and bottom pressure systems in the Southern Ocean should also not be forgotten. Tide model uncertainties in this area are difficult to reduce with presently available altimeter data sets [58] and can propagate into seasonal and longer timescale errors in estimates of ocean transports.

A selection of priority gauge sites based on criteria (a-c) is given in Annex IV and Figure 5.9 and has been designated GLOSS-OC. As with GLOSS-LTT, this selection contains some sites which are not in the GLOSS core network. Recording frequency requirements will be similar to those for GLOSS as a whole (Chapter 7).

In addition, one should not ignore the potential for data from many mid-latitude continental coastline gauges to supply information on deep ocean circulation, although it is difficult at present to make a comprehensive list of priority locations for this purpose. One application would be when sea level reflects regional changes in the wind field. Of course, this is most obvious in coastal areas with large shelves, such as the NW European shelf, where sea level adjusts to local wind stress [59]. However, Thompson [60], Sturges and Hong [61] and Greatbatch et al. [62], for example, have demonstrated how the Atlantic wind field

can be used to model changes observed in tide gauge data at the western boundary, and it is possible that other western boundary systems could be monitored similarly [66]. As the reliability of oceanic wind fields continues to improve by means of scatterometry, wind and geodetically-controlled coastal sea level data will provide an ideal complement to direct measurements of deep ocean sea surface gradients via altimetry.

Gauges may also be desirable at locations where altimetric sampling is insufficient to provide a proper study of important regional dynamics which should be included in circulation models (e.g. [63]) and/or where there is a danger that large high frequency signals may be aliased by altimetric sampling into apparent seasonal and longer variability. (Clearly, altimetric sampling will be generally less capable of addressing variability of a few days or less (e.g.[64]), although in many cases higher frequency fluctuations will have little relevance for global circulation and climate studies).

The interannual variability in sea level records is a major constraint on their full exploitation for long term trend studies [9,32], whether that variability stems from meteorological forcings, as in the above examples, or from steric changes in deep ocean circulation, as can now also be inferred from numerical models [65]. Conversely, one can argue that the sea level records provide some of the longest climatological time series, and that their variability is not so much a "problem" as a valuable indicator of the changing forcings. This demonstrates the symbiosis between "OC" aspects of our research, in the use of sea level data for development of circulation models with predictive sea level capability, and "LTT" aspects, for an understanding of as much as possible of the sea level variability spectrum leading to more accurate estimation of underlying trends.

Such topics, relevant to LTT and OC studies, have been discussed by a number of working groups [15] and are currently being studied by others [66]. Most recently, the Upper Ocean Panel (UOP) of CLIVAR concluded the following [67]:

- a) It is clear from detailed comparisons between tide gauges and altimetry that better information is required on local dynamical variations in the vicinity of gauge sites in order to optimise comparisons and make the most of both data sets. This will be important for two reasons: to improve comparisons for GLOSS-ALT purposes, and to improve our knowledge of the deep ocean variations from long tide gauge records by removal of the local effects.
- b) A number of studies are underway through model/data comparisons and assimilation to try to understand which gauge sites provide the best information to models. This is necessary for selecting the optimum set for climate forecast models, and selecting such a set for providing backup information to models in case the altimeters fail.
- c) There is a need for carrying out combined studies of altimetry and tide gauges to appreciate what the historical tide gauge signals (pre-altimetry) tell us about the ocean circulation.

Consequently, it seems that, while attempts can be made to devise a GLOSS-OC set for ocean circulation research, we are not yet at a point where we have sufficient knowledge from model/altimetry/tide gauge analyses to compile an optimum set.

5.2 GEOCENTRIC CO-ORDINATES OF TIDE GAUGE BENCHMARKS AND MONITORING OF VERTICAL LAND MOVEMENTS AT TIDE GAUGES

Over the past few years, considerable developments have taken place with the Global Positioning System (GPS) and other advanced geodetic techniques (e.g. DORIS) in order to provide precise geocentric positioning of tide gauge benchmarks, and, over periods of typically a decade of repeated or continuous monitoring, of rates of vertical movement of the marks.

Geocentric coordinates of the benchmarks are required if the tide gauge measurements are to be located within the same global geodetic reference frame as altimeter data. As the benchmarks will move over time for geological reasons, repeated (or continuous) GPS measurements are required. Absolute gravity measurements are now also accurate enough to detect these vertical crustal movements.

Vertical land movements have been known for many years to be an important signal in tide gauge sea level records (Figure 3.4). However, it was not until the recent developments of the new geodetic techniques that it became possible to consider monitoring them. In 1993, the IAPSO Commission on MSL and Tides (CMSLT) (Annex III) organised the "Surrey Workshop" on this topic [12] and recommended:

- (i) The President of the IAPSO CMSLT should formally request that the International GPS Service for Geodynamics (IGS) take on the additional duties of organising and managing the operation of the GPS global sea level monitoring network as a fully integrated component of the IGS-IERS International Terrestrial Reference Frame (ITRF). The products should be coordinates and velocities of the tide gauge stations' bench (reference) marks in the ITRF system; and
- (ii) The PSMSL archiving system should be designed to provide the vertical crustal velocities derived from selected IGS solutions, along with explanatory information including experts that can be contacted by users of the system.

In March 1997, the IGS and PSMSL organised a GPS workshop focused on the implementation of the "Surrey recommendations", particularly with regard to the science requirements for long term sea level monitoring at tide gauges, and for altimeter calibration (e.g. GLOSS-ALT). For the first time practical propositions for network organisation and data processing were developed. The IAPSO CMSLT and IAG Section V (Annex III), in consultation with other relevant bodies, will be required to oversee "Science Working Groups" that interface with the IGS or are components of the IGS, at the Associate Analysis Centre level (such as the Regional Network Analysis Centres RNACC), following conventions established by the IGS Densification Project. These arrangements will be relevant especially to the processing of GPS data from potentially one-hundred sites for LTT studies. For the altimeter calibration set of several tens of sites, the IGS itself will be requested to accommodate data processing within existing IGS global analysis and data flow. The workshop also provided recommendations concerning the frequency of generation of GPS products and product types, and working groups on mechanisms for free data exchange.

With regard to the various remaining technical questions related to operating GPS near to gauges, and to the major question of the desirability of permanent receivers as opposed to the use of scarce receivers in campaigns (and to the major organisational problems associated with campaigns in general), the IGS/PSMSL workshop established a Technical Committee to address these issues as soon as possible. The findings of this committee will be included in the proceedings of the workshop to be published in 1997, and the resulting information will be included in future GLOSS training materials. The workshop proceedings [13] also provide essential background scientific discussions of the need for GPS at gauges. These confirm that priority sites to be monitored by GPS are those identified in the previous sections i.e. GLOSS-LTT, -ALT and -OC, with further prioritisation within the large LTT set identified by regional working groups.

5.3 SATELLITE ALTIMETRY AND GLOSS

Probably the most significant single development in sea level research since the 1990 Plan has been the radical improvement in satellite radar altimetry from a promising, if somewhat imprecise, research technique (GEOS-3, Seasat, Geosat, ERS-1) into an accurate and reliable means for monitoring virtually all of the ice-free global ocean. Altimetry also provides a technical link with the glaciology community, of obvious importance to long term sea level change studies.

The greatest advance in altimetry has been within the T/P project, and the scientific literature is replete with examples of the quality of T/P data (e.g. two Special Issues of the Journal of Geophysical Research in 1994 and 1995). However, as good as T/P is, even its most enthusiastic supporter would agree that its record is too short to establish a credible basis for climate studies, and that the historical perspective

of the tide gauge data set is invaluable for the interpretation of altimetry observations. For instance, any global sea level rise observed by T/P must be interpreted in the context of the trend established by the past century of tide gauge data. On the other hand, the spatial resolution of the altimetry will allow a much more effective separation of interannual variability from the longer term trends, and especially from the regional differences in those trends. There must be simultaneous operation of altimetry and tide gauges for the study of global, long term climate-related signals.

One concludes that continuous, fully-calibrated T/P-quality altimetry should now be considered a major component of GLOSS. There are number of satellite altimetry missions being conducted at present (T/P, ERS-1, ERS-2) and being planned for the future (Geosat Follow-On, JASON and ENVISAT). The time line of these missions is shown in Table 5.1. However, only T/P and its follow-on JASON are designed to operate with an accuracy better than 5 cm and this higher performance must be the "Altimetry Standard for GLOSS". Of course, T/P and JASON will serve as a reference for cross calibration of the other missions and thereby they will improve accuracies generally; the combined use of data from the various missions will certainly improve the space and time resolution of sea level observations.

To ensure consistency in linking the different missions together, it is imperative that all the satellite tracking networks be tied to a precisely controlled reference frame (ITRF) provided by the IERS. (This issue is discussed further in Section 6.3). Furthermore, it is essential that a consistent set of globally distributed validation and calibration tide gauges (e.g. GLOSS-ALT discussed above) be used to benchmark all missions. This requires that these tide gauges be reliably positioned in the same ITRF used to compute the satellite orbits.

Previous (and current) altimeter practice has been that each mission has had its own verification site (for T/P there are two; one placed on oil platform Harvest off of California, and the other one at the island of Lampedusa in the Mediterranean). This practice did nothing to identify the small (about 2.5 cm over 3 years) oscillator error shown in Figure 5.7, which was clear in the global tide gauge comparison. More importantly, by having a separate calibration site for each mission, the crucial intercalibration among missions was not possible. Since altimetric satellites seldom last more than five years, the continuation of this practice would effectively preclude their use for decadal and longer sea level change studies.

The organisation of most altimeter projects so far has been through panels of Principal Investigators (PIs) led by a Project Scientist, all of whom are appointed by the agency which owns the satellite (e.g. NASA, CNES, ESA, US Navy). The GLOSS Group of Experts should include Project Scientist or PI representation from current altimeter projects so as to:

- (i) inject expertise on this maturing technique into the existing and evolving, wider GLOSS programme;
- (ii) conversely, ensure that the maximum amount of information on tide gauge sea level recording is inserted into the altimeter projects;
- (iii) via discussion with the Group of Experts, provide advice to IOC on altimetric sea level matters; and
- (iv) encourage the development of joint products, joint training etc.

Table 5.1 Altimeter Spacecraft: Next Decade

1991 1992 1993 1994 1995 1996 1997 1998 1999 2000 2001 2002 2003 2004 2005

ESA ERS-1

----->

U.S./France TOPEX/POSEIDON

----->

ESA ERS-2

----->

U.S. Navy Geosat Follow-On 1

----->

ESA ENVISAT

----->

France/U.S. JASON-1

----->

France/U.S. JASON-2

----->

6. MEASUREMENT TECHNIQUES AND REQUIREMENTS

6.1 TIDE GAUGES

A tide gauge measuring system consists of a sensor which detects either real sea level (i.e. the level of the air-sea interface) or pressure beneath the water surface, and stores the measurements either locally or via telemetry at a processing centre.

There are scientific and instrumental advantages and disadvantages of measuring either parameter, sea level or pressure. Traditionally, the sea surface has been measured by means of a float arrangement mounted above a well which damps out short-period wave motions (Figure 6.1). This procedure is simple and well-proven. However, there are problems related to water density variations in the case of poorly sited gauges, in addition to difficulties arising from the non-linear response of stilling wells to waves and currents (the Bernoulli effect), each of which can produce errors in the measurement of the water level.

An alternative method for measuring the surface level is provided by an acoustic time-of-flight gauge, a large number of which are now in operation around the world. These avoid the problems associated with moving floats and wires in the traditional gauge, but have their own calibration problems, primarily related to air temperature effects (Figure 6.2).

The second parameter which can be measured is pressure at some fixed point below the sea surface MINUS the atmospheric pressure; this difference is usually called "differential pressure". This quantity can be converted to sea level by means of the hydrostatic relationship between pressure, water density and acceleration due to gravity. (N.B. Beware confusion with the term "Sub-Surface Pressure (SSP)" which in oceanographic literature refers to the total pressure measured below the sea surface, i.e. UNCORRECTED for atmospheric pressure. Oceanographers normally require SSP, rather than sea level, as the former directly determines ocean currents). Unlike surface sensing gauges which require a vertical structure such as a jetty for mounting, pressure systems may be designed with the sensor on the sea bed or fixed to rocks or structures off-shore, connected by a pressure tube (in the case of a bubbler gauge) and data cable to the tide gauge equipment nearby. With pressure systems, care is necessary to ensure that the datum level remains constant, and sea water density variations must be monitored (or modelled) for the best accuracy. Figure 6.3 shows a typical bubbler gauge.

Two IOC Manuals [68,69] provide detailed descriptions of each technique, advice on operational methods, and lists of manufacturers. Further information on sea level measurements and quality control quality can be found in other publications [70,71]. In brief, the major requirements for GLOSS stations are [1]:

- (i) sampling of sea level, averaged over a period (e.g. minutes) to avoid aliasing, at intervals of typically 6 or 15 minutes, but in all circumstances the minimum sampling interval should be one hour;
- (ii) gauge timing be compatible with level accuracy, which means a timing accuracy better than one minute;
- (iii) measurements must be made relative to a fixed and permanent local Tide Gauge Benchmark (TGBM). This should be connected to a number of Auxiliary Marks to guard against its movement or destruction [12,68,69]. Connections between the TGBM and the gauge zero should be made to an accuracy of a few millimetres at regular intervals (e.g. annually);
- (iv) the readings of individual sea levels should be made with a target accuracy of 10 mm;
- (v) gauges should be equipped for averaging and rapid sampling, and should be also equipped for automatic data transmission to data centres in addition to recording on site; and

- (vi) sea level measurements should be accompanied by observations of atmospheric pressure, and also winds and other environmental parameters, which are of direct relevance to the sea level data analysis.

By the end of the decade, one expects that all gauges will transmit data in quasi-real time to a processing centre, or that their data loggers will be regularly down-loaded. Regular (e.g. daily) inspection of data informs operators when a gauge is malfunctioning, and leads to overall better long term data sets. Data from gauges in polar or other remote locations will inevitably be inspected less frequently, unless satellite data transmission can be installed. Similarly, data from the relatively few gauges recording only on paper charts will be slow to reach centres for quality-control; these must be considered priorities for upgrading to modern standards.

Operators of gauges must always be aware of possible systematic jumps in sea level time series when one form of recording is replaced by a "better" one. All gauges have systematic errors, but those errors will be irrelevant for time series work if the same technique is used throughout. (Systematic errors could be important for geodetic studies). New technology gauges are, by definition, less well understood than old ones, and they must always be operated alongside the older ones, perhaps for several years, until sufficient experience has been obtained.

The aim of any tide gauge recording should be to operate a gauge which is accurate to better than 1 cm at all times, i.e. in all conditions of tide, waves, currents, weather etc. This requires dedicated attention to gauge maintenance and data quality control.

6.2 GEOCENTRIC CO-ORDINATES OF TIDE GAUGE BENCHMARKS

Advances in geodetic techniques are now making it possible to fix a tide gauge benchmark (TGBM) in a geocentric reference frame to an accuracy of the order of 1 to 2 cm. This enables the sea level determined from the tide gauge to be in the same geocentric reference frame as sea level data from satellite altimetry. This is important for long term altimeter calibration (Section 5.1.3). In addition, if one has good knowledge of regional geoid variations, geodetic positioning allows the vertical datums in different countries and continents to be related, and it enables the absolute, rather than time-varying, ocean currents between geocentrically-located gauges to be calculated (Chapter 3.1 and [4]).

With regard to long term MSL changes, repeated or continuous geodetic measurements can be used to find the vertical crustal movements at tide gauges. These vertical crustal movements can then be separated from the climate related trends in the MSL data. Hence, relative sea level trends determined from tide gauges can be converted to absolute sea level trends, without having to rely on models of some of the geodynamic processes as is done at present.

The recent advances in geodetic techniques are fully described in three workshop reports [11,12,13] and these are recommended for those requiring further details. The report of the second workshop recommended that permanent GPS receivers should be installed at selected tide gauges and that the IGS should take on the role of coordinating this GPS global sea level monitoring network as a fully integrated component of the IGS International Terrestrial Reference Frame. The third workshop was concerned with the many technical and organisational details requiring study in pursuit of such aims, including the additional science requirement since the second workshop of altimeter calibration.

The third workshop was almost entirely concerned with the use of GPS. However, the second report had already emphasised the important roles that the other advanced techniques (VLBI, SLR, DORIS, PRARE and absolute gravity) will continue to have, both for sea level work and for testing models of Earth deformation, e.g. post-glacial rebound and subsidence. For tests of accuracy, it is, of course, necessary to check for systematic errors by comparing the results from different technologies. The long established permanent SLR and VLBI sites are already producing trends in vertical coordinates with uncertainties of the order of 1 mm/year. Fortunately, there are some sites around the world where various space geodetic techniques are collocated, which will enable long term checks to be made on systematic errors. DORIS is of

particular importance as a complementary technique as, not only will it be applicable to monitoring vertical crustal motion, but will also be the main method by which all presently planned altimeter satellites will be tracked. For GLOSS-ALT in particular, it will be necessary to have tide gauges, GPS and DORIS all collocated at the islands used for altimeter calibration and tracking.

Absolute gravimeters in recent years have become much more portable and are now achieving accuracies of 3 to 4 microgals [72]. This is equivalent to 15 to 20 mm of vertical crustal movement and these instruments are being used both at permanent space geodetic sites and near tide gauges. Since the acceleration of a mass in free fall is measured using metrological standards of distance and time, the absolute gravity observations provide a check on the long term vertical crustal movements that is completely independent of the error sources in space geodetic measurements. The ratio of gravity change to crustal movement also gives information on the physical mechanisms involved and can therefore be used to constrain the geodynamical models.

Following the first report [11], several groups carried out GPS campaigns at tide gauges [73,74,75,76]. The overall conclusion is that GPS measurements can be used to fix a TGBM in a geocentric reference frame with a day to day and campaign to campaign repeatability of the order of 10 to 20 mm for the height component. The height component is approximately a factor 2 to 3 more uncertain than the horizontal components due to the greater effects of tropospheric modelling errors, exogenic loading, antenna phase centre variations and multipath problems.

With the height component being the least well determined from GPS and with the success of continuous GPS measurements at the IGS sites, the second and third workshop reports [12,13] have recommended installing permanent GPS receivers at selected tide gauges (e.g. GLOSS-ALT sites and major subsets of -LTT and -OC sites). Continuous GPS measurements of crustal deformations in tectonically active areas, such as California and Japan and areas of post-glacial rebound (Fennoscandia and N.America) have been in operation over the past few years and show that over a period of 5-10 years an accuracy of 1 mm/year can be achieved for the vertical rate.

As opposed to the experience with GPS campaigns at tide gauges, there is, at present, very little experience of making permanent GPS measurements at tide gauges. This is still an area of active research and various technical and scientific issues have to be resolved [13]. Measurements at tide gauges or in a port area can have particular problems due to the environment, such as security, restricted sky visibility or multipath. The issue of exactly what is meant by measurements at a tide gauge needs to be addressed, e.g if the permanent GPS site is, say, 5 or 20 km away from the tide gauge can the accuracy of 1 mm/year at the permanent site be maintained after the geodetic connection to the tide gauge? For many tide gauges repeated GPS campaigns may be the only option. However, these will require even more attention to be paid to the understanding and correction of the various sources of error. Analysis of continuous GPS data sets will improve the understanding of these error sources, which in turn will improve the accuracy of campaign type measurements.

It is clear from the above that setting up a global network of GPS receivers at tide gauges, some permanent and some temporary in campaigns, is still an ongoing research and development activity and a major organisational challenge.

6.3 ALTIMETER DATA

The T/P project has set the standard for altimetric sea level measurements. The repeatability of a one second-average measurement is approximately 5 cm, of which 2-3 cm arises from radial orbit error, and the remainder stems from the various environmental and instrumental correction terms. Altimetry practice usually regards the ocean tide as a necessary "correction", and corresponding major advances have been made recently in global ocean tide models. The T/P project has set a "One Centimetre Challenge" for the Extended Mission (i.e. following the first three years of the project) and for its follow-on JASON Mission, in which the aim will be to drive both orbit and correction term errors down to the centimetre level.

The ERS missions (ERS-1 and -2) have been less precise than T/P because:

- (i) their altimeters are single, rather than dual, frequency yielding poorer ionospheric corrections;
- (ii) their altitudes are approximately 800 rather than 1350 km resulting in greater atmospheric drag and gravity model error influences on orbit computations;
- (iii) ERS-1 was only laser tracked, owing to the failure of the PRARE system, which has worked successfully on ERS-2 although with limited global coverage. Conversely, T/P has been tracked on a near-global basis by DORIS and GPS, in addition to the use of lasers; and
- (iv) the orbit of ERS-1 changed through four major phases limiting the ability to construct a reliable time-averaged sea surface to remove from the instantaneous altimetric measurements. While mean sea surfaces have been constructed, they include in some locations very few samples which tend to be unevenly spaced throughout the year, resulting in biases arising from seasonal or episodic natural sea level variations.

Efforts have been made to constrain the orbits of ERS-1 to those inferred by simultaneous operation of T/P. However, in general, T/P accuracy is approximately twice that of ERS.

Accuracy of the measurement system is all-important and dominates over issues such as choice of repeat track sampling or inclination. Ideally, one would prefer the community to have access to a sequence of T/P-type missions over the same (10 day repeat) ground track, although equally precise altimetry over almost any ground track that repeats over at least a year would be almost as good. If one has non- or long-repeat track missions, such as the Geosat Geodetic Mission, then crossover constraints and other techniques have to be applied.

Any new mission must be designed so that its data can be combined with those from previous satellites as well as possible in order to yield information on decadal time series. While any one of the many corrections involved in altimetry can yield systematic differences between sea level observed by different missions, the following are of primary concern:

- a) using different reference frames in orbit computation;
- b) using different gravity field models in orbit computation;
- c) inconsistent application of internal calibration information (accounts for internal electronic delays);
- d) changes in data processing in mid-mission, not followed later by a complete reprocessing with a single set of algorithms and constants;
- e) using different sea state bias functional forms;
- f) using different tidal models.

While (e) and (f) can be reanalysed by users with sufficient computer power, a) through d) can only be reformed by a handful of groups, and are best done correctly by the agency responsible for placing the instrument in orbit. An effort is currently underway at the Goddard Space Flight Center (GSFC), called "Altimeter Pathfinder Datasets", with the object of combining data from Seasat, Geosat, ERS-1 and -2 and T/P with as uniform a set of corrections as possible.

The possibility of discontinuities between missions is exemplified even within T/P with its two altimeters. Since each altimeter uses a different clock, the small oscillator error problem discussed above affected one and not the other; the disagreement between the two altimeters, coupled with the disagreement of one of them against the global tide gauges, led to a pinpointing of the error. However, even in the absence of such large errors, the globally-averaged sea level from the two altimeters has subtle systematic biases. For example, there is an average 15 mm relative offset between the heights measured by the two T/P altimeters which remains to be explained [77]. Because they are on the same satellite, it is easy to estimate this value by comparing consecutive 10-day cycles, in some of which one altimeter is used and in other cycles the second

altimeter is employed, and by correcting for the bias in routine processing. Between two different satellites, flying at different times, the only hope of detecting such biases is by means of a globally distributed set of accurate tide gauges operating throughout both missions.

This discussion is not intended to denigrate data sets which came from Geosat and ERS altimetry, and which can be expected from the Geosat Follow On, ENVISAT etc. missions in future; the range of missions proposed for the next decade should provide a wealth of new information. In particular, GLOSS has an interest in altimetric coverage of polar ice sheets.

7. DATA COLLECTION, EXCHANGE AND ARCHIVING

7.1 TIDE GAUGE DATA

One of the main functions of GLOSS is to provide for the smooth flow of sea level data from gauges, to national and international centres, and to scientists. Within the 1990 Plan, countries which were "committed to GLOSS" (Chapter 12) were formally obliged to provide monthly and annual values of MSL to the PSMSL, and also to make hourly values of sea level available for international exchange.

Many countries have, of course, provided their raw tide gauge data (e.g. hourly heights) to any relevant Data Assembly Centre (DAC) (e.g. WOCE, TOGA) which requested the information. However, it is interesting that some countries refused to supply their raw data freely for reasons including national security considerations and the need for cost recovery for potentially commercially-valuable information. It is important that GLOSS through IOC stresses to all countries that:

- (i) there are major benefits to agencies in having at least a subset of their raw data holdings available for international study. Experience has shown that many data analysis problems have been resolved after inspection by a wider group of experts;
- (ii) national security cannot nowadays be compromised by the release of tide gauge data. For example, the military requirement for tidal information can now be satisfied by modern numerical models which exist for virtually every point on the world coastline; and
- (iii) in the present case, GLOSS is not requiring ALL raw data from an authority's coastline but only those from designated GLOSS stations.

For the 1997 Plan, we require that countries "committed to GLOSS" make raw tide gauge data available, by the methods described below, in addition to continuing the provision of monthly and annual MSL values, and associated documentation and datum information, to the PSMSL. The raw data are required by GLOSS for three main reasons:

- (i) to provide the possibility for essential quality control checking of the monthly and annual MSL values;
- (ii) to provide access to the higher frequency section of the sea level variability spectrum, thereby aiding interpretation of interesting signals which may be less evident in the monthly means; and
- (iii) to enable long term archiving of these irreplaceable data sets.

In previous years, the size of raw data sets was a major factor in data transmission, storage and quality control. However, such amounts cannot now be considered large, they can be easily transmitted over computer networks, and software packages exist to ease labour-intensive quality control. In brief, reasons (i-iii) demonstrate clearly why raw GLOSS tide gauge data should be collected, stored and distributed, and there is no technical or other constraint which should inhibit that objective.

Sea level, and many other data types, are now transmitted routinely from national authorities to DACs via file transfer protocol (FTP) and electronic mail across the Internet. Similarly, most scientists who wish to acquire PSMSL, WOCE etc. data now do so via FTP connections to the relevant sites. The centres of course continue to provide data on CD-ROM (e.g. see Annex VI), floppy disk etc. to those scientists who cannot use FTP as yet. By the end of the century, the Internet can be anticipated to have truly-global reach, which necessitates a re-think of methods of data flow and of the role of "centres".

For countries "committed to GLOSS", we require that they:

- 1) send all monthly and annual MSL data, and associated documentation, to the PSMSL as previously. If possible, data should be sent by July of the year following the data-year; and

EITHER:

- 2a) send to one or more "International Centre" recognized by GLOSS copies of the raw tide gauge data sets for GLOSS stations (any one GLOSS gauge should be associated primarily with one International Centre to avoid major problems of duplicate data sets)

OR:

- 2b) provide these raw data sets on an FTP or World Wide Web (WWW) server in their own organisation.

The aim in (2) should be to make raw data available with a maximum delay of 6 months. The raw data sets provided by the authority may be after QC or not; it is recognized that a full QC of data sets can take time. It will be important that the data sets are flagged accordingly. The data may be subject to QC subsequently by the International Centre (although that QC will in principle not be as rigorous as the national authority's which should know its own data better), or merely flagged as without QC and archived for future reference, depending on priorities and resources. It will be necessary for each Centre to keep detailed log files documenting data sources, QC histories, and changes and revisions to data sets.

In practice, each International Centre will obtain from the others copies of all data sets relevant to their own activities. For example, a Southern Ocean DAC would copy relevant Southern Ocean records and documentation from the WOCE DACs, and *vice versa*.

Each International Centre recognized by GLOSS will be required to provide full on-line catalogues of both their own data holdings and those of the other Centres. In addition, they must provide FTP or WWW addresses for all national authorities with their own servers. Consequently, if requested data are not available from one site, they can be immediately accessed over the Internet from another. File formats, data quality control standards etc. must be unified so that a user can analyse data sourced from different Centres in the same way. It will be the responsibility of a GLOSS Data Coordination Panel to ensure that this coordination takes place.

International Centres will be created and terminated in response to the requirements of GLOSS and international ocean monitoring programmes. Some will have long periods of operation (e.g. the PSMSL has existed since 1933), others will have finite life (e.g. the TOGA Center has formally ended although it has metamorphosed into the UH WOCE Center). Not all Centres will have an interest in holding on their own servers copies of raw data and documentation for all GLOSS sites. Some Centres may have only a geographically-limited responsibility (e.g. Southern Ocean or Mediterranean), others may be responsible for data relevant to a programme rather than a region (e.g. WOCE). However, all Centres will propagate GLOSS Standards, in the most general sense, into their individual programmes.

The necessary flexibility within these arrangements can be provided if:

- (i) the number of Centres is relatively small and GLOSS undertakes the coordination discussed above;
- (ii) at regular intervals, for example every year, and at the termination of a Centre's operations, each Centre sends complete copies of its data holdings to an International Archiving Centre (IAC) where data will be archived. IACs should include the PSMSL and the World Data Centre for Oceanography, but could also include any other Centre willing to function as an IAC.

The welding of different Centres and national authorities into one distributed sea level information network (Figure 7.1) is an interesting challenge for the Data Coordination Panel to address. It by no means

need be a high cost one. However, developments such as provision of completely-electronic documentation, which surely is a requirement in the twenty-first century, could imply relatively greater emphasis on resources other than tide gauges than previously.

Several of the Centres, and especially the GLOSS-ALT Centre, will need access to raw tide gauge data more rapidly than the 6 monthly updates described above. For example, the WOCE "fast" activity already attempts to acquire maximum amounts of data within about 2 months.

We have suggested that GLOSS-ALT requires data within one month of acquisition. That can certainly be provided by most of the authorities with gauges in the GLOSS-ALT set, with relatively minor improvements in efficiency in data chains, allowing for each authority to take a first look at its own data for QC purposes, and then for transmission by FTP to the GLOSS-ALT Centre. Where gauges have inadequate telephone or satellite transmissions, and when they are required for higher-priority programmes such as GLOSS-ALT, then of course the appropriate investment must be made in "real-time" transmission.

7.2 GEODETIC DATA FOR MONITORING VERTICAL LAND MOVEMENTS

Over the past decade, the GPS technique has developed rapidly to the extent that it is of fundamental importance to many areas of geophysical research. The IGS receives data from a global network of GPS stations (Figure 7.2) and produces information on the orbits of the GPS satellites which is significantly more precise than the ephemerides routinely transmitted by the satellites themselves. This information is employed subsequently by researchers with GPS receivers (for example, at tide gauges) in precise positioning computations. GPS data from the IGS network are archived at the IGS Central Bureau.

A number of groups in Europe, North America, Japan, Australia etc. are performing GPS measurement campaigns at tide gauge sites. However, there are several concerns with regard to data flow. In particular, there are as yet no clearly defined mechanisms for archiving the GPS data from these campaigns (or from permanent GPS receivers at the gauges) other than by the groups themselves, many of which are small teams of university researchers. In addition, there are a number of software packages for GPS data processing which appear to provide systematically different results. Resolution of these questions will require further research and organisation by the GPS community. Many of these issues were discussed most recently at a workshop in March 1997 [13] and an IGS/PSMSL Technical Committee has been appointed by the workshop to consider topics in greater depth.

The DORIS technique has also been proved to be capable of monitoring vertical land movements although with somewhat lower accuracy than GPS [12]. DORIS data available at present can be acquired through the Institut Géographique National in France (Annex V).

Absolute gravity has also been recognized as being capable of providing important information on land movements [12]. However, the number of sites and their data sets will be considerably smaller than for GPS, and measurements near to gauges have not yet become routine. Data flow aspects of this technique should be reviewed in 2-3 years time.

7.3 ALTIMETER DATA

It is necessary to distinguish several different types of altimeter data products of use to those interested in sea level observations (as opposed to those interested in instrument performance and algorithm development):

- (i) the "GDR", Geophysical Data Record. It contains approximately 1 second alongtrack samples of all the key variables measured onboard, after suitable calibration and validation: latitude, longitude, time, altimeter range, satellite height, geoid, mean sea surface, significant wave height, wind speed, integrated water vapour, ionospheric electron content, modelled tidal height, as well as dozens of auxiliary variables and flags. The volume is approximately 500 megabytes per month (MB/month), whichever mission is discussed;

- (ii) a "streamlined" data set. This has only latitude, longitude, time, and sea surface height above some time-mean. The data are alongtrack every 1 second. The corrections cannot be undone if they are found to be suspect, since they are not included in the product. The volume is some 30 MB/month. Most experienced users who acquire the GDRs make a "streamlined" dataset for their private use. The "Altimeter Pathfinder" dataset from GSFC and the combined T/P and ERS-1 sea level anomalies from CLS-Argos/AVISO (see below) are public versions in this category;
- (iii) maps, on a suitable uniform space-time sampling. Once gridded, the data cannot be used for some applications (for example, near coasts or to retrieve propagating waves that may have been blurred by the space-time averaging). The volume is about 3 MB/month.

The GDR altimeter data are provided to scientists by data centres contracted to the space agencies which operate the satellites. The Physical Oceanography Distributed Active Archive Center (PODAAC) at the Jet Propulsion Laboratory in the USA, and the Archiving, Validation and Interpretation of Satellite Data in Oceanography Organisation (AVISO) in Toulouse, France distribute T/P data, while ERS data are provided by the Centre ERS d'Archivage et de Traitement (CERSAT) facility in France, and Geosat and Geosat Follow-On are obtained from the National Oceanic and Atmospheric Administration/National Oceanographic Data Center (NOAA/NODC) in the USA. These data centres also handle data types other than altimetry. For example, CERSAT processes and distributes wind data from the ERS scatterometers. NODC has a large collection of *in-situ* ocean data. PODAAC has wind data from the NASA scatterometer, as well as data from the Seasat altimeter, scatterometer and microwave radiometer. CD-ROM is the medium most often used for data exchange.

GDR Formats, algorithms, documentation etc. for the two recent missions (T/P and ERS-1) are quite different. Of course, this is inevitable to some extent as there are instrumental differences between T/P and the ERS satellites. However, the result is that there are in effect two altimeter user communities which overlap only at the large international conferences. There are few joint products, although important first steps have been made by AVISO.

Research groups usually require one or two local specialists to be responsible for following all the complexities of developments in data types such as altimetry. At present such effort-sharing is often provided by collaboration. However, it is clear that steps must be taken by the space agencies to standardise their products as far as possible.

Space missions, and space instrumentation such as altimeters, are extremely complex. The major difficulties of tide gauge data centres in obtaining and cataloguing full details of tide gauge operations appear modest ones when one considers the amount of information which should be preserved for posterity from altimeter missions. It is impractical to expect such copious technical information to be preserved outside of the agencies which constructed and operated the satellites.

At the present time, there is no official centre, which would parallel the PSMSL's responsibilities for long term tide gauge data collection and storage, with regard to long term archiving and distribution of altimeter data in as unified a manner as possible. While NASA's data centre for altimetry, PODAAC, or CNES's AVISO, or ESA's CERSAT have no long-term guarantee of funding, as opposed to NOAA's NODC, the space agencies appear to recognize the need to hold useable data for long periods. For example, NASA's PODAAC has existed for over 15 years, albeit with different names but with the same institutional commitment (JPL's), and manages the data from NASA's SEASAT satellite (1978), together with the more recent T/P (1992) and NSCAT (1996, which measures wind speed and direction over the oceans) as well as data from other ocean-viewing satellites. It is imperative that all space agencies acknowledge the need for long term handling of their data, which includes both holding old and lower level data, and also reprocessing old data to take advantage of advances in algorithms and to extract further information from them (Geosat orbit estimates were good to 1 m in 1987, which required losing long wavelength information to remove orbit error; 1996 estimates of the Geosat orbit are better than 10 cm, permitting new signals to emerge). This is precisely what NASA's "EOS Pathfinder Datasets" programme funds.

The discussion of the availability of the streamlined and gridded datasets is postponed to Section 8.7.

7.4 OTHER DATA SETS FOR SEA LEVEL RESEARCH

Historical tide gauge records in the form of paper charts or tabulations, which may not have been investigated in detail so far, must be preserved in good condition. The success of "data archaeology" projects, such as that conducted by IOC and NOAA for oceanographic station data (e.g. XBTs, CTDs and Nansen casts) [78], emphasises the importance of similar activities in sea level fields (e.g. [79]).

There are several other sources of sea level information apart from tide gauges and altimetry. For example, bottom pressure recorders (BPRs) used extensively by UK, US and French groups can provide proxy-sea level data from the deep ocean if water column density changes can be measured or modelled adequately in order to correct for baroclinic fluctuations. Instruments can be deployed for periods up to five years [80], and their data sets are especially important in areas such as the Southern Ocean where ice precludes full altimetric coverage and where hostile environmental conditions make conventional tide gauge measurements extremely difficult [29,30,31].

A related factor is the need for surface air pressure data, either to convert measured sub-surface pressures into equivalent sea level or to convert sea level records into sub-surface pressure for ocean circulation studies. If station air pressures are not available, pressure values, together with wind stress and other meteorological data, should be obtainable from model hindcasting, although for the last few decades only at present.

A major sea level research issue is determining when the present 10-25 cm/century rise first started, as it is larger than the mean rate one would infer from geological and archaeological data from the past 2000 years. It is possible that sea level has risen and fallen by several decimetres on century timescales (e.g. due to the Little Ice Age) but the situation is not clear. More data from the past two centuries would be very welcome. It is vital to record all possible archaeological markers of sea level change, before many are destroyed by coastal developments.

The acquisition of further sea level data from the late Holocene is being undertaken by International Geological Correlation Programme (IGCP) Project 367 "Late Quaternary coastal records of rapid change", sponsored by UNESCO and the IUGS. It is also being undertaken by the INQUA Commission on Quaternary Shorelines, and by a wide network of research institutes and university groups. These data, especially those as far back as possible to the last glacial maximum, will be used to validate geophysical models of ice-ocean-lithosphere interactions.

8. SEA LEVEL DATA SETS, PRODUCTS AND SERVICES OF MAJOR CENTRES

One of the primary functions of GLOSS is to organise the preparation of various sea level products, for the benefit of the scientific community, governments of Member States and the general public. This chapter provides an overview of tide gauge and altimeter data products and services currently available from several centres.

8.1 PSMSL

Since 1933, the Permanent Service for Mean Sea Level (PSMSL) has been responsible for the collection, publication, analysis and interpretation of sea level data from the global network of tide gauges [81]. It is operated under the auspices of ICSU and is a member of the Federation of Astronomical and Geophysical Data Analysis Services (FAGS). It is based at the Proudman Oceanographic Laboratory (POL), Bidston Observatory, by means of support from the UK Natural Environment Research Council.

As of October 1996, the database of the PSMSL contains 42500 station-years of monthly and annual mean values of sea level from approximately 1750 tide gauge stations around the world received from over 170 national authorities (Figure 8.1). On average, approximately 2000 station-years of data are entered into the database each year.

The PSMSL is also responsible to the IAPSO CMSLT (Annex III) for the databanking of pelagic tidal constants. Plans have been made with the Commission for the expansion of this activity to include tidal constants from selected conventional gauge sites in order to aid tide model developments.

All PSMSL data are available via "Anonymous FTP" (Annex V) at the same address used by the WOCE "delayed mode centre". Data are also available on CD-ROM and can be provided on an *ad hoc* basis on floppy disk or on computer printouts. Data can also be obtained via the PSMSL WWW information pages (Annex V). Some of these pages show global maps indicating where sea level has risen and fallen each year relative to a base period (e.g. Figure 8.2a,b). Other pages provide information and contact names covering not only the PSMSL itself but also the other international centres.

A wide range of publications are produced by the PSMSL. The PSMSL publishes on its web server a newsletter for the global tide gauge community called the *GLOSS Bulletin* which has two issues per year. Printed publications include brochures, data holdings summaries, workshop reports, and reports to IOC and UNESCO for large international conferences [82].

The FTP disk contains a bibliography of technical publications relevant to the PSMSL and GLOSS while review articles by the PSMSL Director and other authors provide a guide to the large number of scientific publications which have made use of the data set. Probably the most important recent scientific publications are those of the 1990 and 1995 IPCC Scientific Assessments [9,83]. The PSMSL provides a link to recent publications for third world scientists without access to extensive library facilities by undertaking keyword and other library searches; the POL library holds probably the largest collection of sea level literature in the world.

The PSMSL organises major international meetings on the themes of sea level changes and tides, e.g. "60th PSMSL Anniversary Meeting (1993)" and "Tidal Science 1996".

The PSMSL attempts to stimulate the development of tide gauge networks within other countries and regions (e.g. "EuroGLOSS", see below). It has hosted ten IOC/GLOSS training courses on sea level measurements and analysis, and it supplies a Tidal Analysis Software Kit (TASK) package for tidal research.

In collaboration with IOC, it provides an essential coordination role for GLOSS, including the production of the GLOSS Station Handbook PC and CD-ROM product (Annex VI). It maintains full participation with altimeter working groups.

8.2 WOCE SEA LEVEL CENTRES

A global network of sea level gauges provides WOCE with *in situ* data for ground truth calibration of satellite altimeter missions, as well as estimates of surface geostrophic currents. Many of the WOCE stations (Figure 4.2) are also GLOSS sites.

The WOCE "fast" delivery centre is operated by the University of Hawaii Sea Level Center. As of July 1996, hourly, daily and monthly sea level time series covering the T/P data period were available from 102 stations. For 61 stations, the existing time series has been extended backward to 1985 in order to connect Geosat altimetric data with the present T/P data set. All data are updated every month and are distributed via the Internet (Annex V).

The WOCE "delayed mode" delivery centre is operated by the British Oceanographic Data Centre which has the responsibility for assembling, quality controlling and distributing the comprehensive WOCE sea level data set [84]. As of October 1996, the centre maintains contact with 125 sites, of which 117 are operational, with data from 109 of those represented in the data set. Most data are available via the Internet (Annex V).

8.3 UNIVERSITY OF HAWAII SEA LEVEL CENTER

The UHSLC collects, processes, and distributes sea level data and products in support of various multi-national field programs and for climate and global change research. The UHSLC has four primary functions:

- (i) the maintenance of the Indo-Pacific Sea Level Network (IPSLN), an array of 42 tide gauges, most with satellite data telemetry, located in the tropical portions of the Indian and Pacific Oceans;
- (ii) the collection and quality assessment of sea level data from various contributors world-wide (including the IPSLN) for inclusion in the "Research Quality Data Set" (see below);
- (iii) the collection of sea level data from various contributors world-wide for distribution in near-real time as part of the "fast" WOCE data set; and
- (iv) the production of sea surface topography maps (monthly) and diagnostic time series (quarterly) for the Pacific Ocean as part of the IGOSS Sea Level Project in the Pacific (ISLP-Pac) (see below).

The UHSLC has played a major role in the development of GLOSS, for example by providing one of the WOCE Centres. It has provided a range of sea level data sets and products, participated in training courses and has provided quality control and tidal analysis software to the community [85].

Research is also conducted at the UHSLC with the data collected by its subordinate activities. Areas of interest include: tropical ocean dynamics, calibration of altimetry data with *in situ* sea level data, climate variations on interannual and decadal time scales, the impacts of climatic events on fisheries, and the development of new cost-effective methods for data collection and station maintenance.

8.3.1 The TOGA/RQDS Sea Level Data Set

The TOGA sea level data collection activity was described in Chapter 4. The TOGA sea level centre collected data originating from many sources, of which the UH Indo/Pacific sea level network was the primary one. The centre was charged with collecting sea level data from the global tropical ocean, quality controlling and distributing them within 18 months whenever possible.

Though the TOGA program has officially ended, the UHSLC will continue to provide this function as its "Research Quality Data Set" (RQDS). The centre will continue to collect sea level data from the global ocean, and quality control and distribute them within 18 months whenever possible. This will include data

from oceanographically strategic locations both within and beyond the tropics, and the RQDS already forms one of the largest global collections of hourly sea level information. As of July 1996, the UHSLC RQDS holdings include 335 sites with 4512 station-years of quality assured data (Figure 4.1). These data are submitted each year to the US-NODC and to the World Data Centre system and an annual progress report is produced. All of the UHSLC data have been available on the Internet via FTP and the WWW (Annex V). A CD-ROM of the RQDS (formally TOGA data set) was made available in 1994.

8.3.2 IGOSS Sea Level Programme in the Pacific (ISLP-Pac)

This activity was a successful pre-altimetric example of operational oceanography within GLOSS. The ISLP-Pac project was established for the purpose of making monthly mean sea level data available to a wide circle of users in a timely fashion, and to generate products that would be valuable for scientific analysis of climate-related processes. A pilot project started in June 1984 and a permanent programme was established in 1988. During the pilot project and in the first year of the permanent programme, maps of the sea level deviations from the mean sea level were produced without any missing months (Figure 8.3). Since January 1988, maps of the anomaly of sea level from the 1975 to 1986 mean annual cycle of sea level have also been generated. This anomaly is also corrected for the inverted barometer effect using the atmospheric pressure fields computed at the National Meteorological Center (Figure 8.4).

Additional products were also developed during the pilot project. These included time series of the volume of the tropical Pacific Ocean (published quarterly) and indices of the equatorial current system (published annually). The volume time series has received much attention because of its importance for El Niño prediction and analysis.

All ISLP-Pac products are included in the IGOSS Products Bulletin published quarterly by IOC and WMO, and are available via the Internet.

8.4 NATIONAL TIDAL FACILITY, FLINDERS UNIVERSITY

8.4.1 Australian Baseline Array

The Australian Baseline Array of tide gauges (Figure 8.5) was initially planned to include eight high precision Aquatrak acoustic water level sensors to form an Australian baseline monitoring system at strategic locations. However, during prior investigations for the most suitable equipment, a Letter of Understanding was drawn up between the National Tidal Facility (NTF) and NOAA. Through this agreement, NOAA provided three extra baseline stations, and equipment for test facility local to the NTF at Port Stanvac, which is also used as a monitoring station. All stations were installed between May 1990 and June 1992. Due to NOAA funding cuts, the joint stations are now fully maintained by the NTF. Subsequently, cooperation with GEMCO Mining Co. has added another installation at Groote Eylandt in the Gulf of Carpentaria (September 1992), while cooperation with CSIRO has resulted in the establishment of a "ground truth" station for the T/P project at Burnie in Tasmania (September 1993).

The baseline array data set is also enhanced by the access to data from a set of gauges installed by the Port of Melbourne Authority. Whilst these gauges do not have the same full array of ancillary meteorological sensors, they do have the high precision Aquatrak sensor.

8.4.2 Sea Level Project for the Southern Ocean (SLP-SO)

The objectives of this programme are to improve understanding of sea level variations across the Southern Ocean, and to foster increased international cooperation into oceanographic research in the region. As there is considerable interest in sea level measurements in the Southern Ocean [29,30,31], a centre for Southern Ocean sea levels has been established at the NTF with funding from the Australian Government (Figure 8.6). Feasibility studies for various sea level products are in progress, especially with regard to providing a monitoring of the Antarctic Circumpolar Current.

8.4.3 South Pacific Sea Level and Climate Monitoring Project

The project is a joint initiative of South Pacific Forum member countries (Figure 8.5). It aims to help Pacific island countries and their governments understand the scale and implications of changing sea levels and climate. The project includes: (i) setting up high resolution sea level monitoring stations at 11 island countries; (ii) carrying out a supplementary survey and geodetic programme; (iii) helping identify changes to sea levels; (iv) collaboration with on-going international geodetic programmes; and (v) undertaking training. Participating countries in the project are: Australia, Cook Islands, Fiji, Federated States of Micronesia, Kiribati, Marshall Islands, Nauru, Niue, Papua New Guinea, Solomon Islands, Tonga, Tuvalu, Vanuatu and Western Samoa. The project is supported by the Australian Agency for International Development (AusAID). The NTF was contracted to develop and manage the project. The NTF and the South Pacific Regional Environment Programme (SPREP) collaborate in the implementation of the project.

Software for tidal analysis and prediction is available from the NTF produced originally for use within the ASEAN sea level project which ended in 1995.

8.5 UNIVERSITY OF SÃO PAULO (USP)

The USP publishes for IOC a newsletter in Spanish and Portuguese called the *Afro-America GLOSS News (AAGN)*. This includes many articles on sea level measurements and analysis, and is distributed widely throughout South America and Africa. Issues are produced every 6 months. The AAGN provides a complementary method of spreading news of GLOSS to the *GLOSS Bulletin*, which contains articles in English on the WWW.

8.6 INTERNATIONAL HYDROGRAPHIC ORGANISATION

Many of the Hydrographic Authorities of the 62 Member States of the International Hydrographic Organisation (IHO) are actively concerned with the observation of tidal levels, both for the application of tidal height to reduce sounding measurements to Chart Datum, and for prediction of tidal heights for the information of mariners using nautical charts.

A computerised Tidal Data Constituent Bank, operated for the IHO by the Canadian Hydrographic Service, archives and supplies data on request for over 4000 tidal stations. A catalogue of stations has been published by the IHO [86]. The data are available from this bank in accordance with agreed procedures [87], and the bank is regularly updated as new constituents become available.

8.7 ALTIMETER DATA CENTRES

As explained in Section 7.3, the main centres for distribution of altimeter GDRs are NASA's PODAAC, CNES's AVISO, ESA's CERSAT and NOAA's NODC (Annex V). In addition, many research groups generate the "streamlined" and "gridded" products mentioned in 7.3 and make their products available over the WWW. Among these are:

- (i) the altimeter pathfinder activity at GSFC, which has streamlined data for T/P, ERS-1 phase C, and Geosat;
- (ii) AVISO distributes a streamlined product for T/P and ERS-1 created at CLS-Argos;
- (iii) University of Texas at Austin makes available a 10 day x 1 degree x 1 degree global grids of T/P sea level;
- (iv) NOAA's Laboratory for Satellite Altimetry prepares a spatially coarser grid, optimized for low latitude studies where zonal correlation is longer than meridional correlation, in near-real time (a few days delay) with T/P and ERS-2 data;

- (v) the University of Colorado at Boulder has a high resolution, near-real time, sea level combination of T/P and ERS-2 optimized for mesoscale variability and eddy tracking, and an interactive subsetting and map generation facility;
- (vi) other products are available at the Technical University of Delft.

The reader can find the WWW addresses, together with email contacts, in Annex V. In addition, the WWW sites for the large agency data centres usually include pointers to these other more focused products.

The 1990 GLOSS Implementation Plan contained a reference to NOAA's commencement in 1988 of an IGOSS Pilot Project on Altimetric Sea Surface Topography (IPP-ASST) in order to investigate the utility of altimeter data (Geosat) to mapping of global sea level changes [1]. That project was successful, particularly in mapping the large changes in the Pacific. It has since been superseded by a set of demonstration products including T/P global maps of sea level anomalies (e.g. Figure 8.7) and deviations, and estimates of global-average sea level change (Figure 3.5). Anomaly maps for the western Pacific based on blended ERS-1 and TOGA tide gauge data were produced for several years but have since been discontinued.

9. OTHER REGIONAL SEA LEVEL PROJECTS

Over the past few years, a large number of regional activities have started, focusing on sea level monitoring and coastal impacts. Some of these based at the major centres were mentioned in the previous chapter. However, several more should be mentioned, which altogether form a research programme spanning most parts of the globe. Almost all projects have been initiated by groups of countries in order to address issues of common concern, e.g. flood and storm surge forecasting. Most projects have worked closely with GLOSS and have nominated contact persons. For some projects, specialised sea level centres have been set up to collect data and generate useful products. Projects which might be mentioned, each of which is at a different stage of development, include the following:

9.1 MONITORING SYSTEM FOR SEA LEVEL MEASUREMENTS IN THE MEDITERRANEAN (MEDGLOSS) (CIESM/IOC)

Several countries of the Mediterranean have proposed an operational network of tide gauge stations in the Mediterranean and Black Seas (MedGLOSS), a region where coordinated sea level data collection has been intermittent to date [88]. This proposal has since been adopted by CIESM and IOC as a joint activity and as a regional extension of GLOSS. Five sub-regions have been identified: the Western Mediterranean, the Adriatic Sea, the Central Mediterranean, the Eastern Mediterranean and the Black Sea. Focal points will be established for each sub-region in order to address specific needs and identify the necessary programme adjustments in their respective sub-regions; focal points will be also responsible for the correct operation of the MedGLOSS stations and optimal flow of high quality data. A distributed system will be established in order to facilitate direct access of data sets from any location.

MedGLOSS will have both operational and non-operational (i.e. non-real time) components. Besides addressing global issues and meeting the needs of GLOSS in general, MedGLOSS will also aim to directly meet the demands on regional, sub-regional and national scales. In its initial phase, MedGLOSS will focus on building a structure that benefits from existing national initiatives, provides scope for mutual support and coordinates individual efforts in synergy with plans for a future regional role. The short-term objectives should therefore rely on a network that mainly handles data in delayed mode. Rescue and compilation of historical data is also vital. Amongst the operational activities envisaged within MedGLOSS, the use of satellite altimetry, the assimilation of data in numerical models for weather and ocean forecasting, and the need to establish warning mechanisms in vulnerable areas have been highlighted.

9.2 OTHER EUROPEAN SEA LEVEL ACTIVITIES

9.2.1 EuroGLOSS/EPTN

In the last two years, separate proposals for a continent-wide combined tide gauge and GPS network in Europe for sea and land level monitoring have been prepared by oceanographic and geodetic experts. The separate proposals ("EuroGLOSS" and the "European Primary Tide Gauge Network (EPTN)", Figure 9.1) have since been combined [89]. A GLOSS meeting in 1995 [28] confirmed general community interest in the proposal.

9.2.2 EOSS (EU)

The European Sea Level Observing System (EOSS) is a European Union (EU)-funded project initiated in the Netherlands which aims at establishing discussion and coordination groups across a range of tide gauge, altimetry, geodetic etc. activities. It has no funds to perform such work itself, the objective is to stimulate proposals which will attract multinational funding.

9.2.3 SELF (EU)

SELF (Sea Level Fluctuations: physical interpretation and environmental impact) and its follow-on SELF-II have been the latest in a series of EU-funded projects into European sea level changes since the mid-1980s. The emphasis in this case is on the Mediterranean and Black Seas. During SELF (1992-95), benchmarks at a number of Mediterranean gauges were connected into a geodetic reference frame by means of GPS, water vapour radiometer measurements were undertaken to study troposphere effects on GPS data, first absolute gravity measurements were made near gauges, geological sea level markers were investigated at selected sites, and studies of sea level variations from the historical tide gauge data set were performed [76]. SELF-II (1995-98) aims at the realization of broadly based and highly interdisciplinary research work, which will use the determination of absolute sea level and of its variations in a comprehensive way to study the present interactions, as well as of those of the recent past, between the ocean, the atmosphere and the Earth's crust, and to develop models suitable to address future requirements.

A number of GPS campaigns at tide gauge benchmarks have been performed in Europe including UKGAUGE [73], EUROGAUGE [74], Baltic Project [75], and SELF [76] with some commonality provided through EUREF. The various EuroGLOSS/EPTN/MedGLOSS/EOSS proposals would aim to weld these separate activities into a coherent monitoring system for the continent. The GLOSS Group of Experts have suggested mechanisms within which such coordination might take place [100].

9.3 CARIBBEAN ACTIVITIES

9.3.1 Sea-Level Programme within the IOC Sub-Commission for the Caribbean and Adjacent Regions (IOCARIBE)

GLOSS development within IOCARIBE has been a high priority activity of the IOCARIBE Group of Experts on Ocean Processes and Climate (GE/OPC). With funding from the IOC, UNEP, and IOCARIBE Member States, more than a dozen new tide gauges have been established since 1989. Most of these gauges are GOES telemetering acoustic units, and many have ancillary meteorological and water sensors. In a recent development, a joint Organization of American States/Global Environment Fund (OAS/GEF) project is (World Bank) funded to install 18 acoustic/GOES tide gauges at sites in eleven of the thirteen CARICOM (Caribbean Community) nations which signed the 1992 Framework Convention on Climate Change: Antigua and Barbuda, Bahamas, Barbados, Belize, Dominica, Grenada, Guyana, Jamaica, St. Kitts and Nevis, St Lucia, and Trinidad and Tobago. These units will be fully instrumented to monitor climate change including sea level, air and sea temperature, wind velocity, barometric pressure, plus other site-specific instruments (e.g. insolation, precipitation, salinity, etc.). At the completion of the IOC/UNEP, OAS/GEF, and Member States' funded projects, the IOCARIBE GE/OPC will have coordinated the modernization and completion of a real-time network in the Caribbean Sea, Gulf of Mexico, Bahamas, and northeast South America. The next priority for the GE/OPC is to establish a regional tsunami warning network utilizing the modernized regional GLOSS tide gauges and seismic sensors. Annex VIII provides an overview of IOCARIBE gauges.

9.3.2 Height Investigations to Broaden Information both on Mean Sea Level Changes and Understanding of Surface Vertical Movements in the Caribbean and Adjacent Regions (HIBISCUS)

HIBISCUS is a proposal for measurements in the Caribbean and adjacent regions, similar to those conducted in the Mediterranean during SELF. The region contains a number of VLBI and SLR geodetic sites in addition to an expanding tide gauge network. These activities would be enhanced by GPS and absolute gravity measurements and a sea level research programme.

9.4 IOC REGIONAL COMMITTEE FOR THE CENTRAL EASTERN ATLANTIC (IOCEA)

GLOSS development in the IOCEA region has been slower than expected. With about 19 coastal countries in the region, only one gauge (Lagos in Nigeria) is known to be fully functional and supplying data to the PSMSL. This is because many of the others lack spare parts, maintenance, consumables and trained

personnel. Two operating stations (Lagos and Dakar in Senegal) are equipped with acoustic Next Generation Water Level Measuring System gauges, while Lagos also has a working float gauge from an original set of four gauges donated by Sweden.

In 1996, IOC provided gauges, donated by Sweden and assembled for use by Germany, to Nigeria, Guinea, Gambia and Cote d'Ivoire. Earlier IOC-funded gauges were installed in 1992 in Nigeria and Ghana. IOC has recognized the need to improve the GLOSS network in the IOCEA region. In particular, the following points can be made [28]:

- (i) there is a need for a detailed regional survey to collect first hand information on the status of GLOSS stations and the possibility of either establishing new stations or refurbishing old ones;
- (ii) training of regional scientists in the installation, maintenance, collation and analysis of tide data should be intensified;
- (iii) efforts are needed for regular maintenance of existing and proposed stations;
- (iv) transfer of tidal data and information between scientists in the region should be coordinated;
- (v) increase participation of regional scientists in global sea level activities is needed.

9.5 INDIAN OCEAN ACTIVITIES

9.5.1 Pilot Monitoring Activity on Sea Level Changes and Associated Coastal Impacts in the Indian Ocean (SLP-IO)

The objectives of this project are:

- (i) to improve understanding of the processes that control sea level variability in the Indian Ocean; and
- (ii) to enhance capabilities of countries in the Indian Ocean to monitor and analyse sea level data.

The project envisages setting up of a network of Cells for Monitoring and Analysis of Sea Level (CMAS). The task of the scientists associated with each CMAS will be to secure high quality sea level data recorded in their region of responsibility and to analyze these data to understand the variability observed. The details concerning implementation of the project are summarized in [90] while background may be found from minutes of a regional workshop in Tanzania in 1994 [91] and a series of training seminars in India in 1995 [92].

The following countries have established CMAS: Bangladesh, India, Kenya, Madagascar, Malaysia, Maldives, Mauritius and Mozambique. In addition, Tanzania participates in the activities of the Pilot Activity, Seychelles has offered to support it by making sea level data from its stations available to interested researchers, Australia, through its National Tidal Facility, lends active support to the Pilot Activity and Sri Lanka has expressed interest in setting up a CMAS in the near future. The Pilot Activity provides a framework for cooperation amongst CMAS, the IOC, UNEP and WMO so that the goals set by each CMAS are met.

9.5.2 IOC Regional Committee for the Co-operative Investigation in the North and Central Western Indian Ocean (IOCINCWIO)

IOCINCWIO countries have cooperated in the development of a GLOSS regional component in the Western Indian Ocean. In the 1990 GLOSS Plan, tide gauge stations were proposed in Djibouti, Somalia, Kenya, Tanzania, Seychelles, Mozambique, Madagascar, Mauritius and at Dzaoudzi and Pointe des Galets in the French Comoros and Reunion islands. An IOCINCWIO Regional GLOSS Coordinator has been appointed (Annex IX).

In 1985, the only stations in the region operating were at Zanzibar, Dzaoudzi and Pointe des Galets. Since then, several stations have been installed by UH as part of TOGA, including Mombasa, Mogadishu, Port Louis, Rodrigues, Port Victoria and Agalega. Two stations were installed in Madagascar. In Mozambique, the National Institute for Hydrographic and Navigation (INAHINA) has installed two GLOSS stations at Pemba and Inhambane. Specialists have attended training courses in the UK and India. Several countries have participated in SLP-IO (previous section).

Many countries in the region require assistance in maintaining and upgrading stations and in training specialists in sea level measurements, interpretation and analysis. Good communication links are lacking in some countries.

9.6 OPERATIONAL SEA LEVEL CENTRES

Tsunami and storm surge warning are two of the most obvious examples of operational uses of real-time sea level data. "Operational and real-time" implies a national or regional activity, rather than a global (GLOSS) one. Nevertheless, GLOSS must always take advantage of and complement such activities wherever possible.

9.6.1 The IOC Tsunami Warning System in the Pacific

The Tsunami Warning System in the Pacific (ITSU), established by the IOC in 1965, is a cooperative effort for tsunami mitigation involving many Pacific Member States. Activities of ITSU are guided by the International Coordination Group for ITSU and are supported by the IOC as well as the Member States. The IOC and NOAA maintain the International Tsunami Information Centre (ITIC) in Honolulu, Hawaii. The ITIC works closely with the Pacific Tsunami Warning Centre (PTWC) in Ewa Beach, Hawaii, with other warning centres, with scientific bodies, and with emergency management organizations to help carry out the ITSU mission. The PTWC, also maintained by NOAA, is the operational headquarters of the Tsunami Warning System. It cooperates with other regional and national centres in monitoring seismic and sea level data from around the Pacific in real- or near real-time. Large earthquakes in the Pacific Basin are detected by PTWC within a few minutes of their occurrence from seismic data. Based on the computed location, depth, and magnitude of the earthquake, a tsunami warning and watch may be issued by PTWC for a limited region surrounding the epicentre. Data from sea level gauges nearest the epicentre are then examined to determine the presence and size of the tsunami as the wavefront passes each instrument's respective position. The warning/watch region is then either expanded or cancelled by PTWC as appropriate. In the case of a large tsunami, the sea-level network will provide essential data needed by the warning system to track and evaluate the waves as they propagate across the entire Pacific Basin in less than a day. Data from sea level gauges are also used for post-tsunami analyses and research. Figure 9.2 shows some of the key seismic and sea-level stations of the Pacific network. Plans are being made for the establishment of a similar system in the Indian Ocean.

9.6.2 Storm-Surge Warning System in the North Sea

An ideal example of operational, as opposed to research, use of sea level data can be found from the North Sea region. The UK Storm Tide Warning Service continuously tests sea level data from the 45 tide gauges of the "National Network" for consistency with predictions of a tide-surge numerical model for the N.W. European Shelf, which uses forecast meteorological information to provide estimates of surge heights up to 5 days ahead [93]. Flood warnings are issued by the Service, and real time gauge data are transmitted to authorities in the Netherlands and Germany. The SeaNet group [94] is aiming to tie together tide gauge and other fixed monitoring networks in the region.

For this regional activity, and for similar projects in other regions, the intention has been for GLOSS standards to be employed wherever possible, thereby raising the quality of sea level data overall. GLOSS

encourages the further development of regional sea level activities and the establishment of close links with the global programme.

Contact names for each of the regional projects are included in Annex IX.

10. TRAINING, EDUCATION AND MUTUAL ASSISTANCE (TEMA) WITHIN GLOSS

IOC has emphasised that the GLOSS programme must continue to contain a strong TEMA component; TEMA is a joint UNESCO-IOC activity dealing with Training, Education and Mutual Assistance in the field of the ocean sciences. The IOC has urged Member States to assist developing countries through TEMA and/or through bilateral and multilateral assistance mechanisms, to enable them to participate actively in GLOSS and to apply the resulting data and information to national practical concerns.

TEMA activities related to GLOSS must include:

- (i) provision of gauge instruments and spare parts;
- (ii) assistance in site selection for GLOSS stations;
- (iii) assistance in the installation of gauges, in training of technicians to maintain the gauges, and of specialists to make maximum local use of the gauge data;
- (iv) assistance in training in the use and applications of the new sea level-related technologies (GPS, altimetry etc.);
- (v) financial support for attendance at relevant international workshops, training courses etc.
- (vi) provision of training materials and other documents related to GLOSS;
- (vii) provision of sea level data sets and a wide range of other suitable products.

This assistance can be provided in two formal ways through IOC:

- (i) via allocations to GLOSS from voluntary contributions to the IOC Trust Fund in accordance with Rule of Procedure No.55 [95]; and
- (ii) via the IOC Voluntary Co-operation Programme [96].

These arrangements for GLOSS will be progressively merged within GOOS Capacity Building, in the interests of GLOSS complementing overall GOOS aims.

However, there are also many informal methods for cooperation which depend primarily upon the mutual interests of scientists from all countries concerned. The coordination of these activities will be undertaken by the IOC Secretariat, as required in each case.

Since 1985, a large number of countries have provided different forms of assistance, either via IOC or via bi/multilateral arrangements. For example:

- (i) the United States of America has assisted in the installation of over 20 tide gauges in the Pacific and Indian Oceans;
- (ii) Australia has assisted the Philippines, Indonesia, Singapore and Thailand in setting up stations;
- (iii) Japan and Australia have assisted Malaysia to develop an extensive sea level network;
- (iv) Portugal has assisted Cape Verde, Sao Tome and Principe and Mozambique in setting up stations;
- (v) the Federal Republic of Germany has employed a consultant to assist in the installation and repair of stations in West Africa using tide gauge hardware donated by Sweden. Stations have been installed in Nigeria, Gambia, Cote d'Ivoire and Guinea;
- (vi) the United Kingdom, the People's Republic of China, France, Brazil, India and Argentina have hosted and organised over fifteen training courses on the science and techniques of sea level measurements and data analysis.

Member States addressing requests for assistance in setting up stations should give as many details as possible regarding existing facilities, equipment required, infrastructure needed (e.g. construction of a suitably secure building for gauge equipment, telephone connections etc.), and implications for training. Any recipient country will subsequently be responsible for committing its appropriate tide gauge authority to provide ongoing gauge maintenance and submission of sea level data for international exchange. In addition, it will be responsible for the support of any visiting foreign consultant dealing with gauge installation, local transport, customs clearances etc.

Upon receipt of such requests, the IOC Secretariat will consult with the GLOSS Group of Experts and tide gauge agencies of other Member States in order to endeavour to meet the request as far as possible.

It is clear that training courses of various kinds need to be an ongoing component of GLOSS in all regions and held in all major languages. IOC will consult with the GLOSS Group of Experts and the wider community in order to establish the criteria for selecting courses of different types and in different regions. However, IOC would also welcome invitations from Member States wishing to host courses, and outlines of course content in response to local needs would be especially useful.

Once a good proposal for a course has been received, then at least one year is required for appropriate IOC funding to be put in place, then to construct an agenda, appoint lecturers, and arrange with other Member States for suitable participants to be invited. Information on courses currently in preparation can be obtained from the IOC Secretariat.

11. PERSONNEL INVOLVED IN THE MANAGEMENT AND INTERNATIONAL COORDINATION OF GLOSS

The operation of GLOSS as an international programme requires an appropriate organisational framework (Figure 11.1) involving a large number of personnel.

11.1 NATIONAL CONTACT POINTS FOR GLOSS

The system of National Contact Points for GLOSS has been found to be a fundamental element in international coordination of the programme. Member States notify the IOC Secretariat of the names of designated National Contact Points (or "GLOSS Contacts"). The GLOSS Contacts then liaise with IOC to promote GLOSS development at a national level as widely as possible.

The specific responsibilities of the National GLOSS Contacts are to:

- (i) promote the implementation of GLOSS within the country concerned, e.g. act between various national agencies to remove bottlenecks;
- (ii) act as contact points for data requests, e.g. provide a link between national and international sea level authorities, or between individual scientists and international centres as necessary;
- (iii) publicise GLOSS and sea level studies in general;
- (iv) provide a channel for IOC communications about GLOSS, e.g. distribute GLOSS documentation and publications to the national institutions and persons concerned, supply information to IOC on training needs and keep the GLOSS Technical Secretary informed on all changes regarding the operation of national GLOSS stations; and
- (v) organise through appropriate national channels systematic inspections of the national GLOSS stations to ensure their operation in accordance with GLOSS requirements.

National Contact Points receive no funding from IOC for their GLOSS activities; the support of National Contacts' activities is one of the commitments required of an IOC Member State participating in GLOSS. Annex IX contains a list of current National Contacts.

11.2 REGIONAL GLOSS CO-ORDINATORS

Regional Contact Points (or "Regional Coordinators") for GLOSS can be nominated for liaison with IOC and the GLOSS Group of Experts if a regional sea level project relevant to GLOSS is established. A Regional GLOSS Coordinator should be active in sea level studies, both in general and in the particular region. The Group of Experts will provide advice to the appropriate IOC Regional Subsidiary Bodies on suitable candidates. Thereafter, continuing close collaboration must be maintained between the Coordinator and the Group. Regional coordinators or project leaders can be invited to attend meetings of the IOC Group of Experts.

The specific responsibilities of GLOSS Regional Coordinators are to:

- (i) liaise generally with IOC, PSMSL and other International Centres, and with National GLOSS Contacts;
- (ii) encourage the adoption of GLOSS measurement and data analysis standards;
- (iii) report to IOC and GLOSS Group of Experts on priorities from the regional viewpoint;

- (iv) organise (typically) yearly meetings of the regional project at which selected National Contacts would attend;
- (v) make the Governments and public of all Member States in the region more aware of GLOSS, especially of course those of States not so actively involved in GLOSS so far;
- (vi) advise IOC on the requirements of the region for training and technical assistance and assist in organizing regional training; and
- (vii) liaise with relevant GOOS regional activities.

Regional Coordinators receive no funding from IOC for GLOSS activities, apart from meeting travel costs. It is expected that Regional Contacts' activities will be supported by respective regional organizations and bodies. Annex IX contains a list of current Regional Coordinators.

11.3 GLOSS TECHNICAL SECRETARY

Central funding from IOC for GLOSS is extremely limited. Most of the progress achieved in GLOSS so far has been obtained by taking advantage of national and international sea level measurement programmes, and of proposals for bi/multilateral collaborations, all of which meet long term GLOSS aims. However, some central funding is clearly required for necessary coordination, for training, and for the stimulation of the development of sea level products required for GLOSS long term.

A most important position within GLOSS has been, and will continue to be, the GLOSS Technical Secretary, who is an IOC staff member. The specific responsibilities of this post are:

- (i) to provide communication between IOC/UNESCO, other international governmental organisations such as UNEP, IHO, international scientific bodies such as IAPSO, National and Regional GLOSS Contacts and the IOC Group of Experts on GLOSS;
- (ii) as part of the links with National GLOSS Contacts, to ensure as far as possible that nationally-committed GLOSS gauges are operational;
- (iii) to provide a secretarial function and other support to the IOC Group of Experts on GLOSS;
- (iv) to manage the IOC budget for GLOSS;
- (v) to act as a broker for donor/recipient equipment arrangements and other forms of aid, and for the organisation of training activities and consultant visits;
- (vi) to oversee publication and distribution of GLOSS publications; and
- (vii) to ensure close liaison with GOOS activities through the Director of the IOC GOOS Support Office.

Annex IX contains the name and address of the GLOSS Technical Secretary.

11.4 IOC GLOSS GROUP OF EXPERTS

The original responsibilities for GLOSS Implementation Plan definition, and associated coordination with other international research and service-oriented programmes, were exercised by an IOC Task Team on GLOSS. In 1988, the IOC Executive Council established an IOC Group of Experts on GLOSS which presently reports to the IOC-WMO-UNEP Committee for GOOS (I-GOOS) and the IOC Governing Bodies [97,98,99,28,100].

The terms of reference of the GLOSS Group of Experts, modified in 1997 [100], require the Group to:

- (i) advise the IOC on the implementation of the GLOSS System, at global and regional levels;
- (ii) work closely with J-GOOS (to be absorbed at the end of 1997 into GSC) and its subsidiary bodies and advise I-GOOS on the integration of GLOSS into GOOS;
- (iii) update the GLOSS Implementation Plan regularly;
- (iv) ensure proper liaison with international research programmes and relevant international organizations;
- (v) provide advice on the development of TEMA components of GLOSS, regarding training of specialists, provision of instruments, their installation and maintenance, and data evaluation and interpretation;
- (vi) report periodically to I-GOOS and the IOC governing bodies.

The composition of the Group is not fixed. Invitation is made from the global pool of expertise, based on perceived progress and priorities. Advantage is taken of meeting location to consult with local scientists and to take part in regional activities. IOC funds travel costs of Group members only, while the host institute attends to meeting costs.

In future, the Group will have full participation from representatives of the new technologies (GPS, altimetry etc.), in addition to its traditional tide gauge interests. Meetings of the Group alongside international scientific, or IOC/UNESCO programmatic, meetings will provide for increased representation, as appropriate, with marginal additional costs.

11.5 GLOSS DATA CO-ORDINATION PANEL

Chapter 7 demonstrated the proposed network of International Centres for GLOSS and the need for standardisation of practices at each Centre. An *ad hoc* GLOSS Data Coordination Panel will be required to oversee this task and advise on technical aspects of software exchange, data standards, QC procedures, product generation etc. Links between tide gauge and altimetric products can be expected to be studied, as can the need for a range of computer-based training materials.

The panel can be expected to perform much of its work via electronic mail. However, a requirement can be anticipated for some travel costs. The panel will be appointed by, and will report formally to, the GLOSS Group of Experts.

11.6 GLOSS TECHNICAL AND SCIENTIFIC CONSULTANTS

The GLOSS Group of Experts has identified what personnel (and other assets) it would like to have should funding be available. A frequently-stated requirement would be for a pool of available part-time Technical Experts, whose function would be to visit Member States and advise on improvements in sea level recording. Selection of such consultants and their missions would be coordinated within GLOSS-related regional activities, and the equivalent of one full-time post would be funded from the GLOSS programme. Over the past decade, IOC and UNESCO have funded several visits to developing countries by consultants on sea level recording. However, not all visits have been connected with GLOSS, and there have not been as many as required.

A second requirement would be for extended funding for an internationally-recognized scientist (or scientists) or the Technical Secretary to visit Member States and present GLOSS and its products and services as appropriate. Such visits as Scientific Consultants will need extensive prior communication between IOC,

each regional activity, each State and scientists concerned in order to tailor agendas. Priority countries might be those which are known to possess sea level recording stations, but from which there are difficulties in data flow. Of course, such visits already take place, but on an *ad-hoc* basis.

12. OBLIGATIONS OF MEMBER STATES WHICH ARE COMMITTED TO GLOSS

Member States of IOC which agree to participate in GLOSS will have a number of responsibilities which must be met from national resources. Member States are required to:

- (i) designate GLOSS National Contacts with the duties as described in Section 11.1;
- (ii) require their national tide gauge authorities which operate tide gauge stations within the GLOSS core network to provide monthly MSL data values to the PSMSL by July of the year following the data-year. MSL data should be accompanied by complete documentation on tide gauge type, location, datums etc. (The PSMSL will also continue to be pleased to accept MSL data from all other gauges as part of its ICSU obligations);
- (iii) make available to one of the designated International Centres values of raw (typically hourly) sea level data from GLOSS stations at intervals of six months. Alternatively, data may be made available via an authority's own computer system updated every six months;
- (iv) make available to the appropriate International Centre values of raw sea level data from selected GLOSS stations at intervals more frequent than in (ii) and as required for that Centre's programme. For example, data from GLOSS-ALT gauges should be provided at intervals of not less than one month;
- (v) upgrade existing GLOSS tide gauge stations which are below the GLOSS standards outlined in this Plan;
- (vi) install new gauges where gaps exist in the present GLOSS network in consultation with the Group of Experts. Highest priority for installation should be given to those stations required for GLOSS-ALT and other major international programmes. In many cases, installations may be made on a bi/multilateral basis, and Member States are encouraged to cooperate through the IOC Voluntary Cooperation Programme to enable as many States as possible to participate in GLOSS;
- (vii) keep the IOC Secretariat informed on all changes with regard to the state of GLOSS stations, data submission and National and International GLOSS Contacts. In this way the "GLOSS Station Handbook" (Annex VI) will kept up-to-date;
- (viii) assist in the development and/or the distribution of a range of altimetric, tide gauge and combined sea level products. Altimetric products in particular should provide powerful training tools for colleges etc.;
- (ix) form international collaborative links with regard to the use of the new sea level related techniques (altimetry, GPS etc.) so that widest possible technology transfer can occur;
- (x) participate in and contribute to GLOSS in its widest sense through training schemes etc. and provide proper coordination with IOC with regard to GLOSS requirements and to the development of regional programmes; and
- (xi) enable National and Regional GLOSS Contacts to fulfil their obligations by providing adequate funding and resources to them.

"Commitments to GLOSS" were provided to IOC by Member States in response to a questionnaire which preceded the 1990 Plan. However, some of those commitments proved to be of little value and they need to be reconfirmed. Consequently, Member States are requested to complete the questionnaire in Annex I as realistically as possible so that the Secretariat can ensure that GLOSS development can proceed most efficiently.

REFERENCES

- [1] IOC. 1990. Global Sea Level Observing System (GLOSS) implementation plan. Intergovernmental Oceanographic Commission, Technical Series, No. 35, 90 pp.
- [2] Pugh, D.T. 1987. Tides, surges and mean sea-level: a handbook for engineers and scientists. Wiley, Chichester, 472 pp.
- [3] Woodworth, P.L. 1993. A review of recent sea-level research. *Oceanography and Marine Biology. An Annual Review*, 31, 87-109.
- [4] Balmino, G., Sabadini, R., Tscherning, C. and Woodworth, P.L. 1996. Gravity field and steady-state ocean circulation mission. Reports for assessment: the nine candidate Earth Explorer Missions. European Space Agency Report SP-1196(1). 77 pp.
- [5] Wunsch, C. and Stammer, D. 1995. The global frequency-wavenumber spectrum of oceanic variability estimated from TOPEX/POSEIDON altimetric measurements. *Journal of Geophysical Research*, 100(C12), 24895-24910.
- [6] Schott, F. and Zantopp, R. 1984. Florida Current: seasonal and interannual variability. *Science*, 227, 308-311.
- [7] Vassie, J.M., Harrison, A.J., Woodworth, P.L., Harangozo, S.A., Smithson, M.J. and Thompson, S.R. 1994. On the temporal variability of the transport between Amsterdam and Kerguelen Islands. *Journal of Geophysical Research*, 99(C1), 937-949.
- [8] Mitchum, G.T. and Wyrski, K. 1988. Overview of Pacific sea level variability. *Marine Geodesy*, 12, 235-245.
- [9] IPCC. 1995. *Climate Change 1995. The science of climate change. Contribution of working group I to the second assessment report of the Intergovernmental Panel on Climate Change*, eds. J.T.Houghton, L.G.Meira Filho, B.A.Callander, N.Harris, A.Kattenberg and K.Maskell. Cambridge: Cambridge University Press. 572pp.
- [10] Tushingham, A.M. and Peltier, W.R. 1991. ICE-3G: a new global model of late Pleistocene deglaciation based upon geophysical predictions of post glacial relative sea level change. *Journal of Geophysical Research*, 96, 4497-4523.
- [11] Carter, W.E., Aubrey, D.G., Baker, T.F., Boucher, C., Le Provost, C., Pugh, D.T., Peltier, W.R., Zumberge, M., Rapp, R.H., Schutz, R.E., Emery, K.O. and Enfield, D.B. 1989. Geodetic fixing of tide gauge bench marks. Woods Hole Oceanographic Institution Technical Report, WHOI-89-31, 44pp.
- [12] Carter, W.E. (ed.). 1994. Report of the Surrey Workshop of the IAPSO Tide Gauge Bench Mark Fixing Committee held 13-15 December 1993 at the Institute of Oceanographic Sciences Deacon Laboratory, Wormley, UK. NOAA Technical Report NOSOES0006. 81pp.
- [13] Neilan, R. and Woodworth, P.L. (eds). 1997. Workshop on methods for monitoring sea level: GPS and tide gauge benchmark monitoring, GPS altimeter calibration. Workshop organised by the IGS and PSMSL, Jet Propulsion Laboratory, 17-18 March 1997.
- [14] Fu, L-L., Christensen, E.J., Yamarone, C.A., Lefebvre, M., Menard, Y., Dorner, M. and Escudier, P. 1994. TOPEX/POSEIDON mission overview. *Journal of Geophysical Research*, 99(C12), 24369-24381.

- [15] Eden, H.F. 1990. Editor, Towards an integrated system for measuring long term changes in global sea level. Report of a Workshop held at Woods Hole Oceanographic Institution, May 1990. Joint Oceanographic Institutions Inc. (JOI), Washington, D.C., 178pp. & appendix.
- [16] WCRP. 1985. First Implementation Plan for the World Climate Research Programme. WCRP Publications Series No.5, WMO/TD - No.80. November 1985.
- [17] McPhaden, M.J. (and 14 others). 1996. The Tropical Ocean Global Atmosphere (TOGA) observing system: a decade of progress. *Journal of Geophysical Research* (in press).
- [18] IOC. 1996. IGOSS plan and implementation programme. Intergovernmental Oceanographic Commission Technical Series No. 43, 56pp.
- [19] Caldwell, P. and Mitchum, G. 1995. TOGA Sea Level Center Annual Report for the Year Ending July 1995. University of Hawaii. JIMAR-95-293, 39pp.
- [20] World Ocean Circulation Experiment (WOCE). 1988. World Ocean Circulation Experiment implementation plan. Volume 1: Detailed requirements. WMO World Climate Programme Research, WCRP-11, 63pp. (WMO/TD-No.242).
- [21] World Ocean Circulation Experiment (WOCE). 1988. World Ocean Circulation Experiment implementation plan. Volume 2: Scientific background. WMO World Climate Programme Research, WCRP-12, 130pp. & annexes. (WMO/TD-No.243).
- [22] Mitchum, G.T. 1994. Comparison of TOPEX sea surface heights and tide gauge sea levels. *Journal of Geophysical Research*, 99(C12), 24541-24553.
- [23] CLIVAR. 1995. CLIVAR (a study of climate variability and predictability) science plan. World Climate Research Programme Report 89 and World Meteorological Organisation Report TD. No.690. 157pp. and appendices.
- [24] Fu, L-L. 1996. Sea level observations for CLIVAR. Report prepared for US Ocean-CLIVAR meeting, San Antonio, Texas, 10-13 June 1996.
- [25] OOSDP. 1995. Scientific design for the common module of the Global Ocean Observing System and the Global Climate Observing System: an Ocean Observing System for Climate. Final Report of the Ocean Observing System Development Panel. Department of Oceanography, Texas A&M University, College Station, Texas. 265pp.
- [26] IOC. 1996. Joint GCOS-GOOS-WCRP Ocean Observations Panel for Climate (OOPC). First session, Miami, Florida, USA, 25-27 March 1996. Intergovernmental Oceanographic Commission Reports of Meetings of Experts and Equivalent Bodies. GCOS Report No.24.
- [27] Pernetta, J.C. and Milliman, J.D. (Eds). 1995. Land-Ocean Interactions in the Coastal Zone: implementation plan. IGBP Global Change Report No. 33, 215pp.
- [28] IOC. 1995. IOC group of experts on the Global Sea Level Observing System (GLOSS), fourth session, Bordeaux, France, 31 January - 3 February 1995. Intergovernmental Oceanographic Commission, Reports of Meetings of Experts and Equivalent Bodies, IOC/GE-GLOSS-IV/3, 18pp. & annexes.
- [29] IOC. 1988. Workshop on sea-level measurements in hostile conditions, Bidston, UK, 28-31 March 1988. Summary report and submitted papers. Intergovernmental Oceanographic Commission, Workshop Report No.54, 81pp.

- [30] IOC. 1991. IOC-SCAR workshop on sea-level measurements in Antarctica, Leningrad, USSR, 28-31 May 1990. Intergovernmental Oceanographic Commission, Workshop Report No. 69, 8pp. & annexes.
- [31] IOC. 1996. IOC/GLOSS-IAPSO workshop on sea level variability and Southern Ocean dynamics, Bordeaux, France, 31 January 1995. Intergovernmental Oceanographic Commission Workshop Report No. 115.
- [32] Douglas, B.C. 1991. Global sea level rise. *Journal of Geophysical Research*, 96(C4), 6981-6992.
- [33] Woodworth, P.L. 1990. A search for accelerations in records of European mean sea level. *International Journal of Climatology*, 10, 129-143.
- [34] Douglas, B.C. 1992. Global sea level acceleration. *Journal of Geophysical Research*, 97(C8), 12699-12706.
- [35] Mikolajewicz, U., Santer, B.D. and Maier-Reimer, E. 1990. Ocean response to greenhouse warming. *Nature*, 345, 589-593.
- [36] Powell, R.J., Birks, A.R., Bradford, W.J., Wrench, C.L. and Biddiscombe, J. 1993. Using transponders with the ERS-1 altimeter to measure orbit altitude to plus or minus 3cm. pp.511-516 in, *Proceedings of the First ERS-1 Symposium, Space at the service of our environment, 4-6 November 1992, Cannes, France, Vol.I, (ed.B.Kaldeich). Noordwijk: European Space Agency. 930pp. (ESA SP-359).*
- [37] Kelecy, T.M., Born, G.H., Parke, M.E. and Rocken, C. 1994. Precise mean sea level measurements using the Global Positioning System. *Journal of Geophysical Research*, 99(C4), 7951-7959.
- [38] Ashkenazi, V., Lowe, D., Moore, T., Rae, J. and Woodworth, P.L. 1994. The use of GPS on buoys. pp.203-212 in, *INSMAP94, Proceedings of the International Symposium on Marine Positioning, Hannover, Germany, September 19-23, 1994.*
- [39] Murphy, C.M., Moore, P. and Woodworth, P.L. 1996. Short-arc calibration of the ERS-1 and TOPEX/POSEIDON altimeters utilising *in-situ* data. *Journal of Geophysical Research*, 101(C6), 14191-14200.
- [40] Mitchum, G.T. 1997. Monitoring the stability of satellite altimeters with tide gauges. *Journal of Atmospheric and Oceanic Technology* (in press).
- [41] Morris, C.S. and Gill, S.K. 1994. Evaluation of the TOPEX/POSEIDON altimeter system over the Great Lakes. *Journal of Geophysical Research*, 99(C12), 24527-24539.
- [42] Murphy, C.M., Moore, P. and Ehlers, S. 1996. Preliminary study of the use of tide gauge data to unify altimetry from separate satellites. Submitted to *Advances in Space Research*.
- [43] Mitchum, G.T. 1997. A proposed tide gauge set for altimeter calibration. To be published in the proceedings of the IGS/PSMSL GPS Workshop [13].
- [44] Garrett, C., Akerley, J. and Thompson, K. 1989. Low-frequency fluctuations in the Strait of Gibraltar from MEDALPEX sea level data. *Journal of Physical Oceanography*, 19(11), 1682-1696.
- [45] Wyrtki, K. 1987. Indonesian through flow and the associated pressure gradient. *Journal of Geophysical Research*, 92(C12), 12941-12946.
- [46] Arief, D. and Murray, S.P. 1996. Low-frequency fluctuations in the Indonesian throughflow through Lombok Strait. *Journal of Geophysical Research*, 101(C5), 12455-12464.

- [47] Bray, N.A. Hautala, S. Chong, J. and Pariwono, J. 1996. Large-scale sea level, thermocline, and wind variations in the Indonesian throughflow region. *Journal of Geophysical Research*, 101(C5), 12239-12254.
- [48] Maul, G.A., Chew, F., Bushnell, M. and Mayer, D.A., 1985. Sea level variation as an indicator of Florida Current volume transport: comparisons with direct measurements. *Science*, 227, 304-307.
- [49] Park, Y-H., Gamberoni, L. and Charriaud, E. 1991. Frontal structure and transport of the Antarctic Circumpolar Current in the south Indian Ocean sector, 40-80E. *Marine Chemistry*, 35, 45-62.
- [50] Vassie, J.M., Harrison, A.J., Woodworth, P.L., Harangozo, S.A., Smithson, M.J. and Thompson, S.R. 1994. On the temporal variability of the transport between Amsterdam and Kerguelen Islands. *Journal of Geophysical Research*, 99(C1), 937-949.
- [51] Woodworth, P.L., Vassie, J.M., Hughes, C.W. and Meredith, M.P. 1996. A test of the ability of TOPEX/POSEIDON to monitor flows through the Drake Passage. *Journal of Geophysical Research*, 101(C5), 11935-11947.
- [52] Meredith, M.P., Vassie, J.M., Heywood K.J. and Spencer, R. 1996. On the temporal variability of the transport through Drake Passage. *Journal of Geophysical Research*, 101(C10), 22485-22494.
- [53] Fofonoff, N.P. 1981. The Gulf Stream system. pp.112-119 in, *Evolution of physical oceanography*, eds. B.A. Warren and C. Wunsch, Cambridge, Mass.: MIT Press.
- [54] Yamashiro, T. and Kawabe, M. 1996. Monitoring of position of the Kuroshio axis in the Tokara Strait using sea level data. *Journal of Oceanography*, Tokyo, 52(6), 675-687.
- [55] Wyrтки, K. 1985. Water displacements in the Pacific and the genesis of El Nino cycles. *Journal of Geophysical Research*, 90(C4), 7129-7132.
- [56] Summerson, R.M.V., Woodworth, P.L., Hughes, C.W. and Tait, M.E. 1997. Coherence between Antarctic tide gauges as an index of variability in the Antarctic Circumpolar Current. IAPSO Conference 1997.
- [57] Jacobs, G.A. and Mitchell, J.L. 1996. Ocean circulation variations associated with the Antarctic Circumpolar Wave. *Geophysical Research Letters*, 23(21), 2947-2950.
- [58] Andersen, O.B., Woodworth, P.L. and Flather, R.A. 1995. Intercomparison of recent ocean tide models. *Journal of Geophysical Research*, 100(C12), 25261-25282.
- [59] Tsimplis, M.N., Flather, R.A. and Vassie, J.M. 1994. The North Sea pole tide described through a tide-surge numerical model. *Geophysical Research Letters*, 21(6), 449-452.
- [60] Thompson, K.R., 1986. North Atlantic sea-level and circulation. *Geophysical Journal of the Royal Astronomical Society*, 87, 15-32.
- [61] Sturges, W. and Hong, B.G. 1995. Wind forcing of the Atlantic thermocline along 32N at low frequencies. *Journal of Physical Oceanography*, 25(7), 1706-1715.
- [62] Greatbatch, R.J., Lu, Y. and De Young, B. 1996. Application of a barotropic model to North Atlantic synoptic sea level variability. *Journal of Marine Research*, 54(3), 451-469.
- [63] Mitchum, G.T. 1995. The source of the 90-day oscillations at Wake Island. *Journal of Geophysical Research*, 100, 2459-2475.

- [64] Woodworth, P.L., Windle, S.A. and Vassie, J.M. 1995. Departures from the local inverse barometer model at periods of 5 days in the central South Atlantic. *Journal of Geophysical Research*, 100(C9), 18281-18290.
- [65] Enfield, D.B. and Harris, J.E. 1995. A comparative study of Tropical Pacific sea surface height variability: tide gauges vs. the NMC data-assimilating OGCM, 1982-1992. *Journal of Geophysical Research*, 100, 8661-8675.
- [66] Gornitz, V. et al. 1997. Design of a global sea level network for monitoring climate variability on seasonal to centennial time scales. Report prepared for the U.S. National Oceanic and Atmospheric Administration. (This report will be included in the proceedings of the International Sea Level Workshop held in Honolulu, USA during 10-11 June 1997).
- [67] C.Koblinsky, private communication, January 1997.
- [68] IOC. 1985. Manual on sea-level measurement and interpretation. Volume 1 - Basic procedures. Intergovernmental Oceanographic Commission Manuals and Guides No. 14. IOC, Paris, 83pp.
- [69] IOC. 1994. Manual on sea-level measurement and interpretation. Volume 2 - Emerging Technologies. Intergovernmental Oceanographic Commission Manuals and Guides No. 14. IOC, Paris, 72pp.
- [70] IOC. 1993. Joint IAPSO-IOC workshop on sea level measurements and quality control, Paris, 12-13 October 1992. (ed. N.E.Spencer). Intergovernmental Oceanographic Commission, Workshop Report No. 81, 167pp.
- [71] Woodworth, P.L., Vassie, J.M., Spencer, R. and Smith, D.E. 1996. Precise datum control for pressure tide gauges. *Marine Geodesy*, 19(1), 1-20.
- [72] Marson, I., Faller, J.E., Cerutti, G., De Maria, P., Chartier, J.-M., Robertsson, L., Vitushkin, L., Friederich, J., Krauterbluth, K., Stizza, D., Liard, J., Gagnon, C., Lothhammer, A., Wilmes, H., Makinen, J., Murakami, M., Rehren, F., Schnull, M., Ruess, D. and Sasagawa, G.S. 1995. Fourth International Comparison of Absolute Gravimeters. *Metrologia*, 32, 137-144.
- [73] Ashkenazi, V., Bingley, R.M., Whitemore, G.M. and Baker, T.F. 1993. Monitoring changes in mean-sea-level to millimeters using GPS. *Geophysical Research Letters*, 20(18), 1951-1954.
- [74] Ashkenazi, V., Bingley, R.M., Chang, C.C., Dodson, A.H., Torres, J.A., Boucher, C., Fagard, H., Caturla, J.L., Quiros, R., Capdevilla, J., Calvert, C., Baker, T.F., Rius, A. and Cross, P.A. 1994. Eurogauge: a west European tide gauge monitoring project. pp.224-233 in, INSMAP'94: International Symposium on Marine Positioning, Hanover, Germany, 19-23 September 1994.
- [75] Kakkuri, J. (ed.) 1995. Final results of the Baltic sea level 1993 GPS campaign. Report of the Finnish Geodetic Institute 95:2. 123pp.
- [76] Zerbini, S., Plag, H-P., Baker, T.F., Becker, M., Billiris, H., Burki, B., Kahle, H-G., Marson, I., Pezzoli, L., Richter, B., Romagnoli, C., Sztobryn, M., Tomasi, P., Tsimplis, M., Veis, G. and Verrone, G. 1996. Sea level in the Mediterranean: a first step towards separating crustal movements and absolute sea-level variations. *Global and Planetary Change*, 14(1-2), 1-48.
- [77] V.Zlotnicki, private communication, March 1997.
- [78] Levitus, S., Gelfeld, R., Boyer, T. and Johnson, D. 1994. Results of the NODC and IOC Data Archacology and Rescue projects. Key to Oceanographic Records Documentation No. 19, National Oceanographic Data Center, Washington, D.C., 67 pp.

[79] Maul, G.A. and Martin, D.M. 1993. Sea level rise at Key West, Florida, 1846-1992: America's longest instrument record? *Geophysical Research Letters*, 20, 1955-1958.

[80] Spencer, R., Foden, P.R., McGarry, C., Harrison, A.J., Vassie, J.M., Baker, T.F., Smithson, M.J., Harangozo, S.A. and Woodworth, P.L. 1993. The ACCLAIM programme in the South Atlantic and Southern Oceans. *International Hydrographic Review*, 70, 7-21.

[81] Woodworth, P.L. 1991. The Permanent Service for Mean Sea Level and the Global Sea Level Observing System. *Journal of Coastal Research*, 7(3), 699-710.

[82] IOC/PSMSL 1994. Sea level monitoring in the small island developing states. Prepared by S.Dowell. IOC/INF-954. 24pp.

[83] IPCC. 1990. Intergovernmental Panel on Climate Change (IPCC). *Climatic change: the IPCC scientific assessment*, edited by J.T.Houghton, G.J.Jenkins and J.J.Ephraums, Cambridge University Press, Cambridge, 365pp.

[84] Dowell, S.L. and Rickards, L.J. 1993. Recent developments in sea level networks and data centres. pp.39-50 in, *Sea level changes and their consequences for hydrology and water management. Proceedings of an International Workshop held at Noordwijkerhout, Netherlands, 19-23 April 1993*. Koblenz: Bundesanstalt für Gewässerkunde. Various pagination. 1993.

[85] Caldwell, P. 1991. Sea level processing software for IBM-PC compatible microcomputers. (Unpublished document). Department of Oceanography, University of Hawaii Sea Level Center, 1000 Pope Rd., Marine Science Bldg. 317, Honolulu, HI 96822.

[86] International Hydrographic Organisation. 1988. IHO tidal constituent bank. Station catalogue. International Hydrographic Organisation Special Publication No.50, 100pp. & appendices.

[87] International Hydrographic Organisation. 1994. IHO Working Group on Standards for the Release of Tidal Data to Commercial Organizations. *International Hydrographic Bulletin*, No.9 (September), 551-552.

[88] Rickards, L.J. 1987. The MEDALPEX sea level data set. *Annales Geophysicae*, 5B(1), 13-20.

[89] Baker, T.F., Woodworth, P.L., Blewitt, G. Boucher, C. and Woppelmann, G. 1996. A European network for sea level and coastal land level monitoring. *Journal of Marine Systems* (in press).

[90] IOC Document IOC/INF-908 (Draft Action Plan for Implementation in the Indian Ocean).

[91] IOC. 1994. IOC-UNEP-WMO-SAREC planning workshop on an integrated approach to coastal erosion, sea-level changes and their impacts. Zanzibar, United Republic of Tanzania, 17-21 January 1994. Intergovernmental Oceanographic Commission Workshop Report No. 96 and supplements.

[92] IOC. 1995. IOC/GLOSS-GOOS training workshop on sea-level data analysis held at the Geodetic & Research Branch of the Survey of India, Dehra Dun, India, 21 November - 1 December 1995. IOC Training Course Reports No.39.

[93] Flather, R.A., Proctor, R. and Wolf, J. 1991. Oceanographic forecast models. In, *Computer modelling in the environmental sciences*, edited by D.G.Farmer & M.J.Rycroft, Clarendon Press, Oxford, pp.15-30.

[94] SeaNet. 1996. SeaNet: European workshop on fixed monitoring networks in the North Sea region. Brochure from SeaNet Secretariat, The Hague, The Netherlands.

[95] IOC. 1982. IOC Manual - Part 1 (Paris, 15 July 1982) (Second Revised Edition).

[96] IOC. 1984. Revised rules for the utilization of the IOC's Voluntary Assistance Programme (IOC-VAP) (IOC/INF-585, Paris, 12 March 1984).

[97] IOC. 1990. IOC group of experts on the Global Sea-Level Observing System (GLOSS), first session, Proudman Oceanographic Laboratory, Bidston, U.K., 19-23 June 1989. Intergovernmental Oceanographic Commission, Reports of Meetings of Experts and Equivalent Bodies, IOC/GE-GLOSS-I/3, 16pp. & annexes.

[98] IOC. 1991. IOC group of experts on the Global Sea-level Observing System(GLOSS), second session, NOAA, Atlantic Oceanographic and Meteorological Laboratory, Miami, USA, 22-26 October 1990. Intergovernmental Oceanographic Commission, Reports of Meetings of Experts and Equivalent Bodies, IOC/GE-GLOSS-II/3, 17pp. & annexes. 1991.

[99] IOC. 1992. IOC group of experts on the Global Sea-Level Observing System (GLOSS), third session, Paris, 13-15 October 1992. Intergovernmental Oceanographic Commission, Reports of Meetings of Experts and Equivalent Bodies, IOC/GE-GLOSS-III/3, 18pp. & annexes.

[100] IOC. 1997. IOC group of experts on the Global Sea-Level Observing System (GLOSS), fifth session, Jet Propulsion Laboratory, March 1997. Intergovernmental Oceanographic Commission, Reports of Meetings of Experts and Equivalent Bodies.

FIGURES

3.1 Mean sea surface dynamic topography from an 8 year run of the Semtner-Chervin numerical ocean model. Contour interval is 20 cm north of 40 deg. S and 40 cm southwards. (Courtesy of Dr. Robin Tokmakian). From [4].

3.2 The geoid heights of the GRIM4-C4 model with respect to the ellipsoid best approximating the Earth. Contour interval is 10 m. From [4].

3.3 Long sea level records from each continent: Takoradi, Ghana (Africa), Honolulu (Pacific), Sydney (Australia), Bombay (Asia), San Francisco (USA) and Brest (Europe). Each record has been offset vertically for presentation purposes. Observed trends for the 20th century are 3.1, 1.5, 0.8, 0.9, 2.0 and 1.3 mm/year respectively. The effect of postglacial rebound as simulated by the Peltier ICE-3G model is less than or of the order 0.5 mm/year at each site.

3.4 Long sea level records from selected sites north to south in western Europe. Each record has been offset vertically for presentation purposes. The apparent fall in sea level at Stockholm is owing to post-glacial rebound of the land. The secular trends in stations further south are comparable to the global average.

3.5 Global sea level change derived from TOPEX/POSEIDON computed by the NOAA group.

4.1 Map of the TOGA/RQDS sea level data set as of September 1996.

4.2 "Delayed mode" WOCE Sea Level Centre holdings as of October 1996. Note that more stations have been data banked in certain coastal areas than were called for by WOCE; these were obtained primarily with the related aim of aiding the development of global tidal models.

5.1 Categories of GLOSS stations within the PSMSL data set as of October 1996 with the network defined by GLOSS93.

5.2 Number of GLOSS stations within each status category, as defined by the PSMSL data set, for recent years.

5.3 Operational and non-operational GLOSS stations as reported in PSMSL questionnaire replies in 1995 [28].

5.4 Stations within the GLOSS core network as defined by GLOSS97.

5.5 (a,b) Sea level stations within the PSMSL data bank with at least 40 or 60 years (Figs. a,b) of data in the Revised Local Reference data set.

5.6 Distribution of tide gauge stations within the GLOSS-LTT set.

5.7 Tide gauge estimates of the drift in TOPEX altimeter calibration (dots) compared to the subsequently discovered altimeter range drift error (solid line). Note that one TOPEX cycle is 10 days. From [40].

5.8 Distribution of tide gauge stations within the GLOSS-ALT set based on [43].

5.9 Distribution of tide gauge stations within the GLOSS-OC set.

6.1 A typical float tide gauge [68].

6.2 A schematic description of an acoustic tide gauge setup [69].

6.3 A schematic description of a bubbler pressure gauge arrangement [68,69].

7.1 Schematic illustration of GLOSS tide gauge data flow. International Centres will include PSMSL, UHSLC, SOSLC etc. Periods shown by arrows indicate the minimum frequency at which data transmission should take place.

7.2 GPS stations of the IGS network.

8.1 Sea level stations within the PSMSL data bank.

8.2 (a,b) Mean sea level positive and negative anomalies for 1990 compared to those over the base period 1979-1990. (Maps on PSMSL FTP server are in colour).

8.3 Deviations of sea level for June 1996 from the long term mean (ISLP-Pac project).

8.4 Anomalies of sea level, corrected for the seasonal cycle and air pressure effects, for June 1996 (ISLP-Pac project).

8.5 Tide gauge network of the Australian Baseline Array and the South Pacific Array.

8.6 Southern Ocean stations represented in the data bank of the Southern Ocean Sea Level Centre as of August 1996.

8.7 TOPEX/POSEIDON-derived deviations of global sea level from the long term average for the spring quarter of 1996 computed by the NOAA group.

9.1 The proposed European EuroGLOSS (dots) and EPTN (diamonds) tide gauge and GPS networks. Not all EPTN stations are at gauge sites.

9.2 Seismic and sea level stations of the Pacific Tsunami Warning Network.

11.1 Organisation flowchart of the GLOSS Programme.

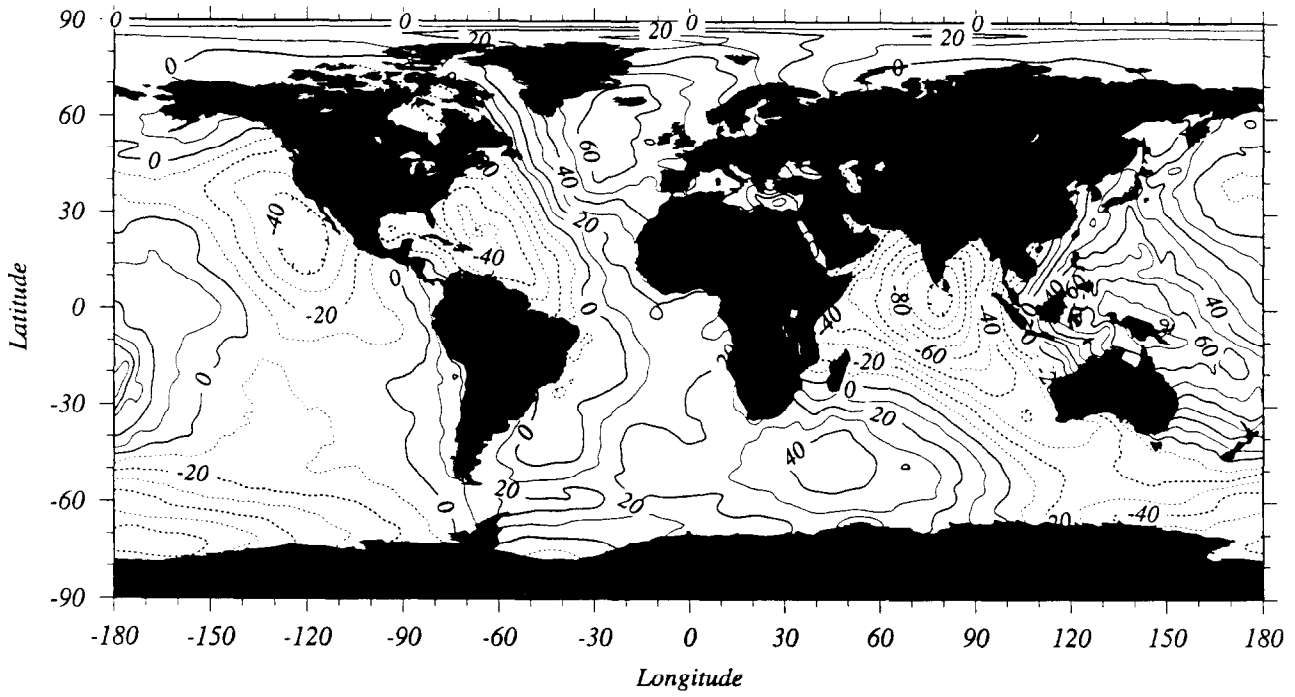
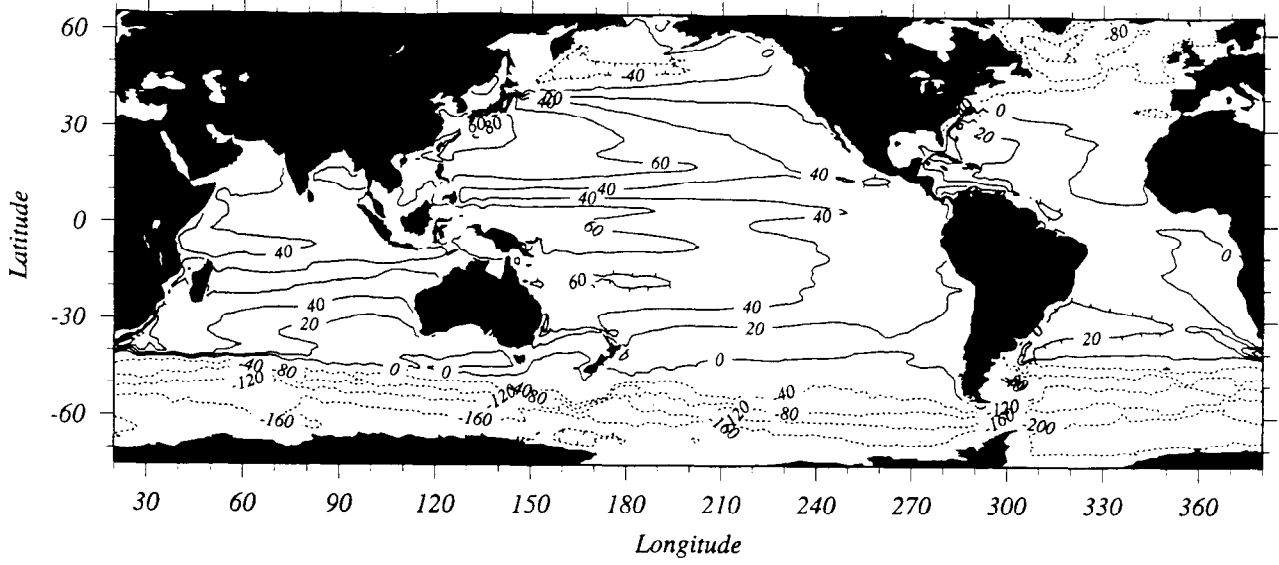

Figures 3.1 and 3.2

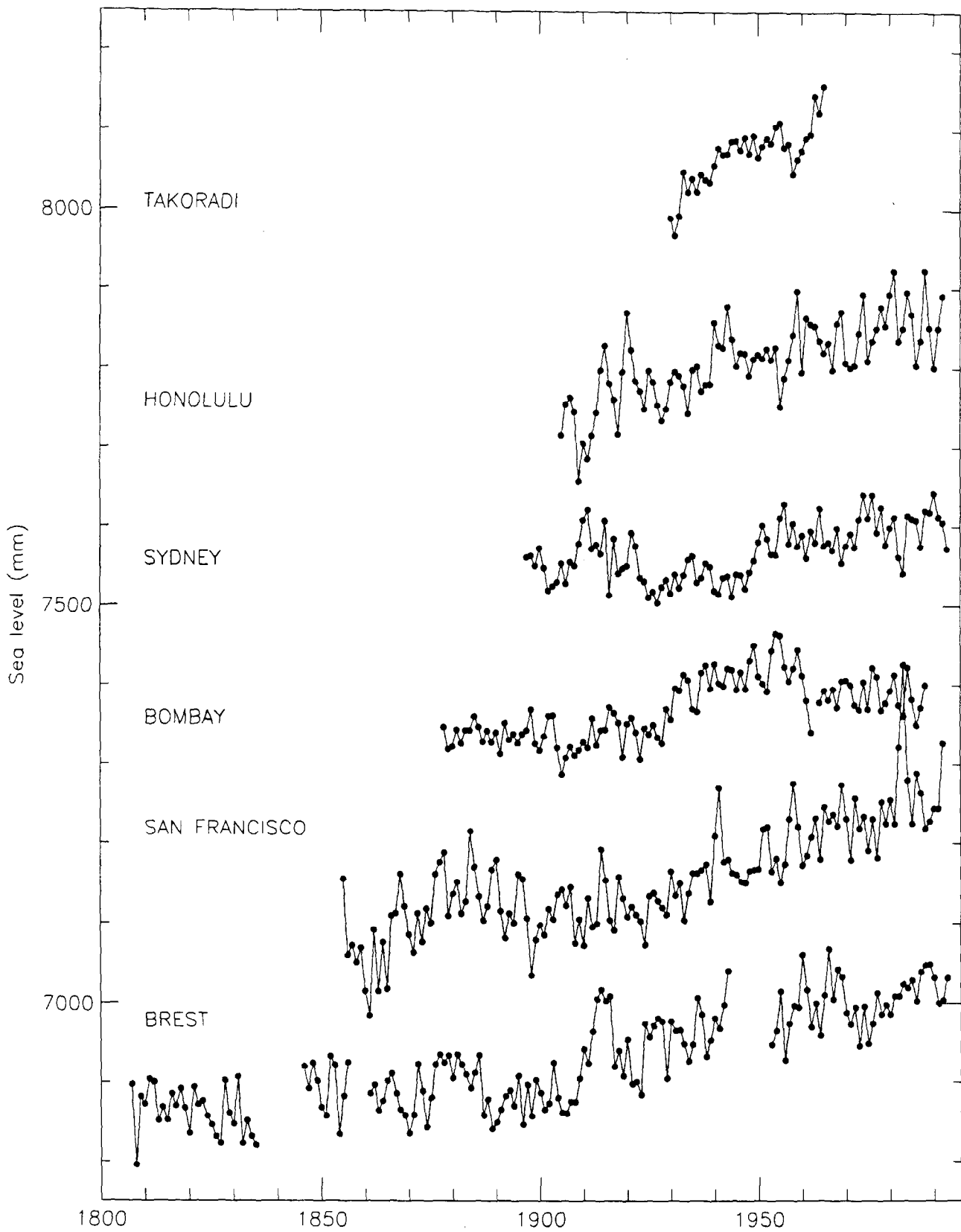

Figure 3.3

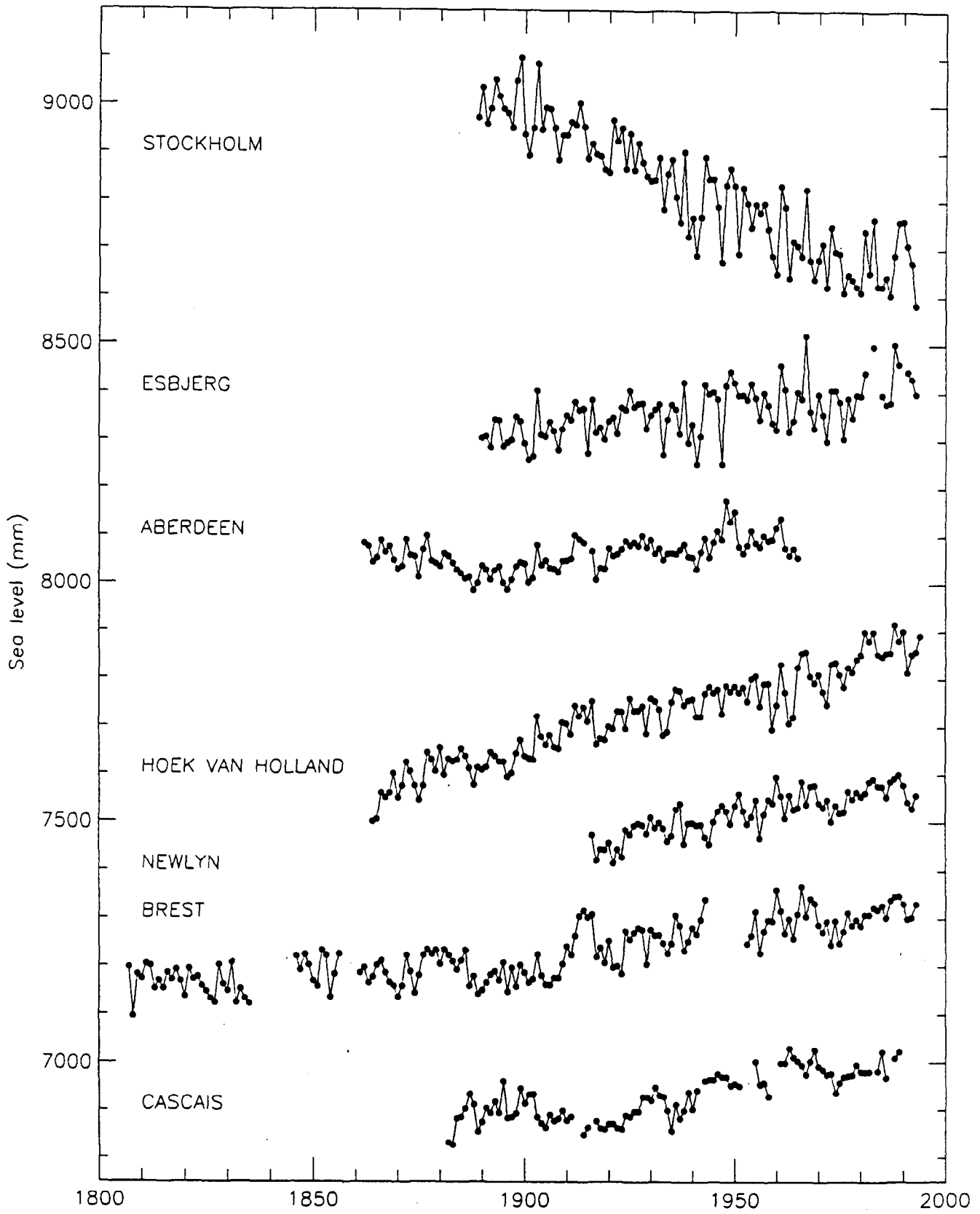

Figure 3.4

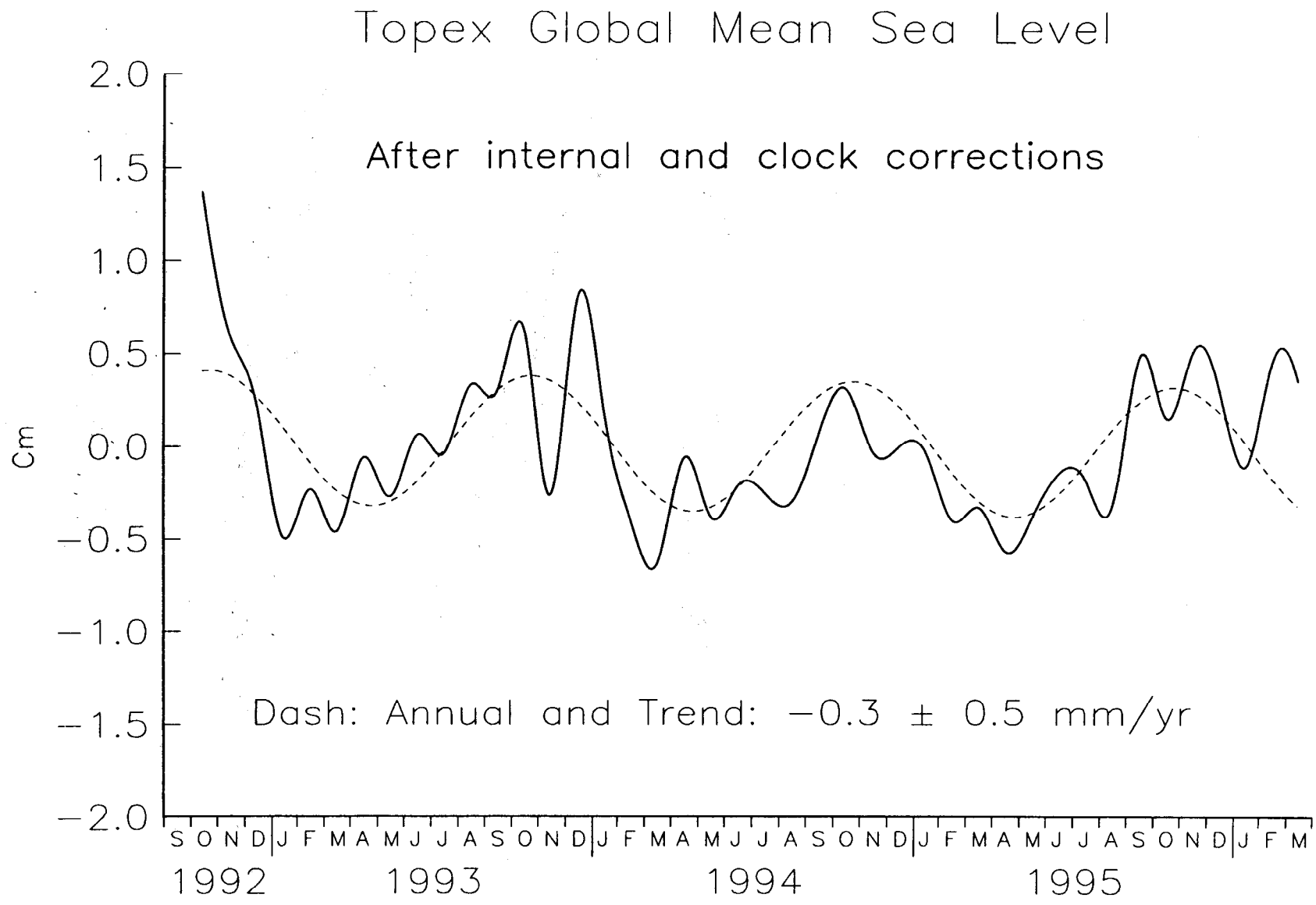
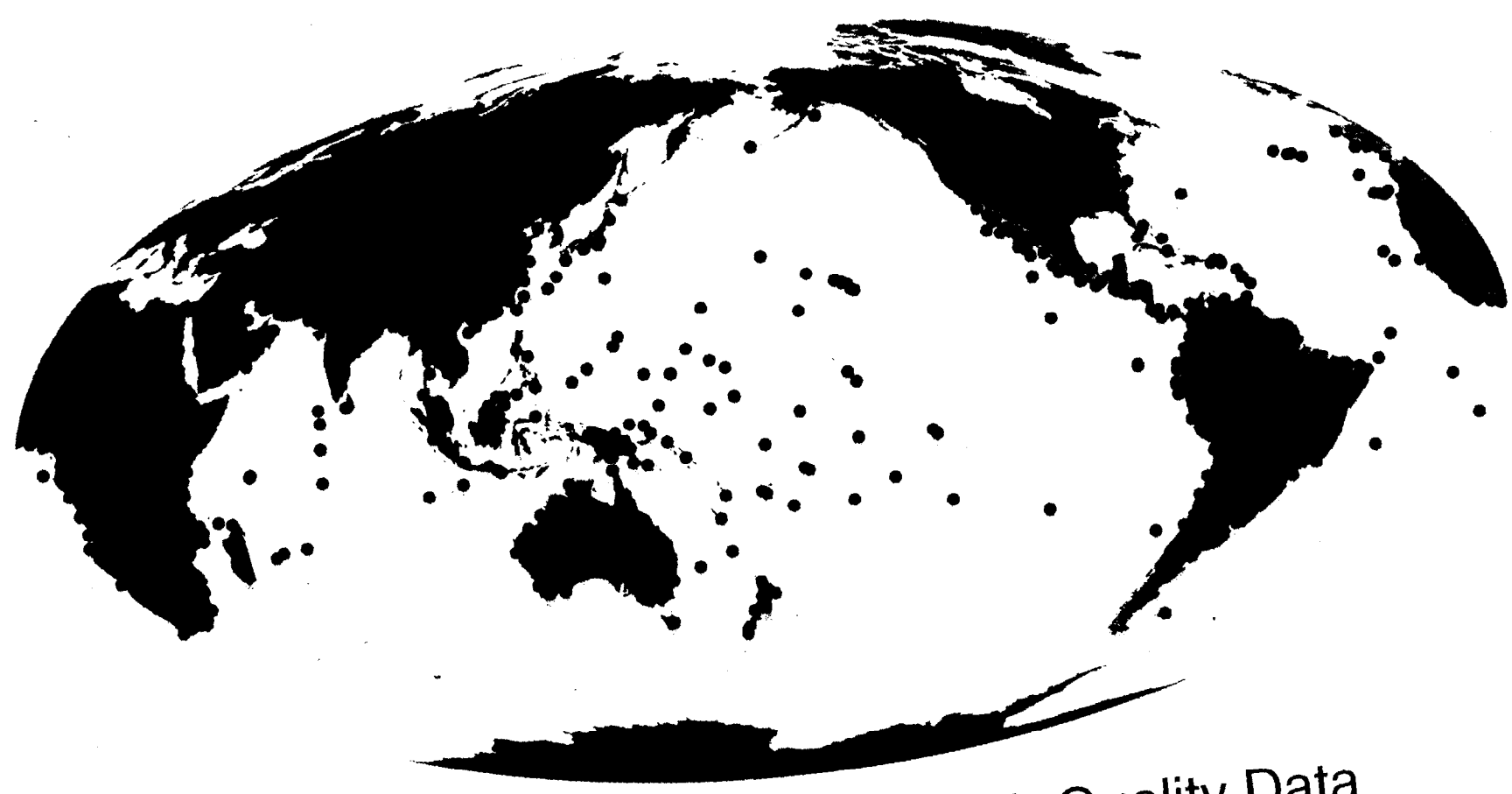

Figure 3.5

Figure 4.1



UH Sea Level Center Research Quality Data

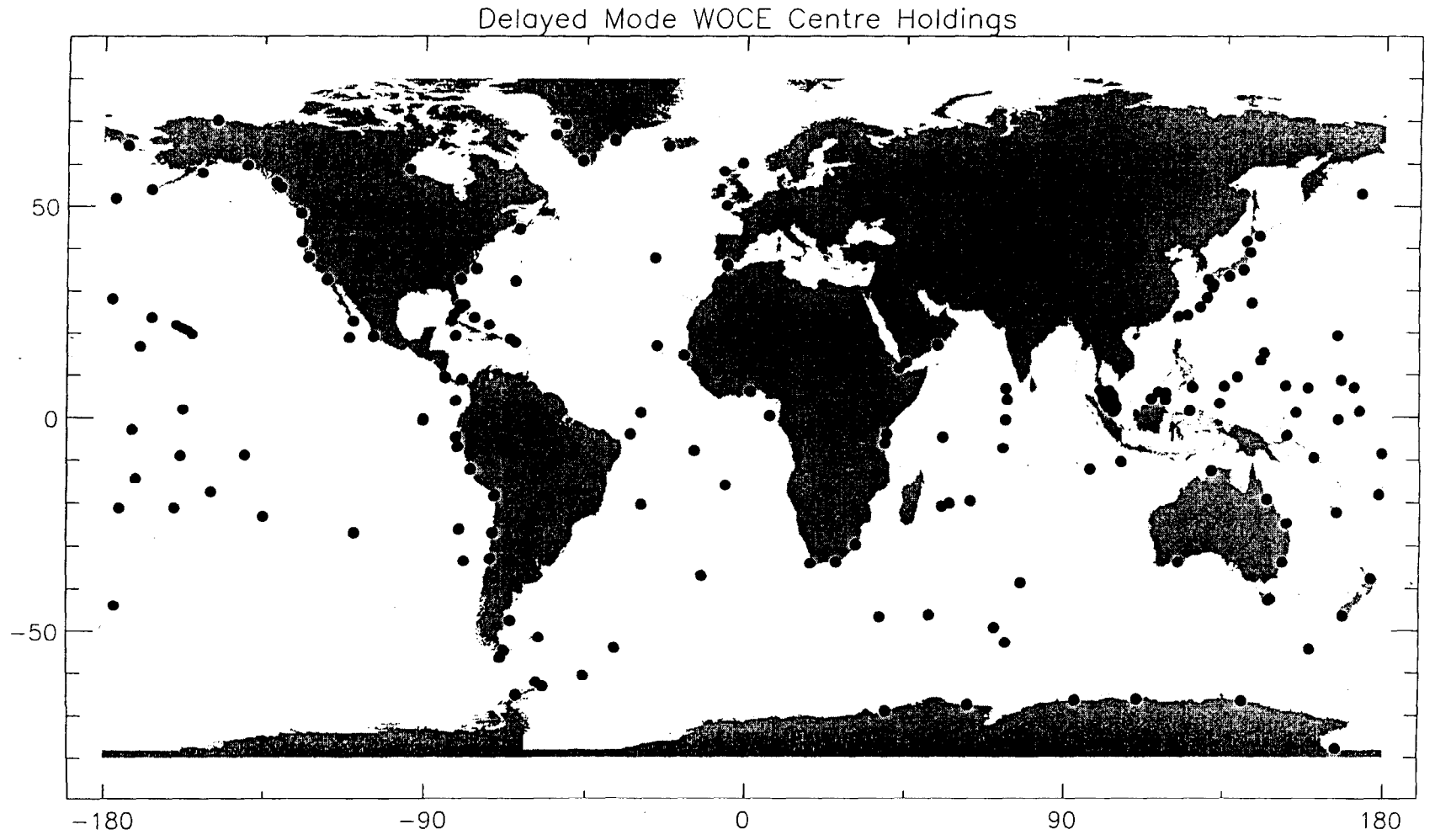

Figure 4.2

GLOSS Status Within the PSMSL Data Set October 1996

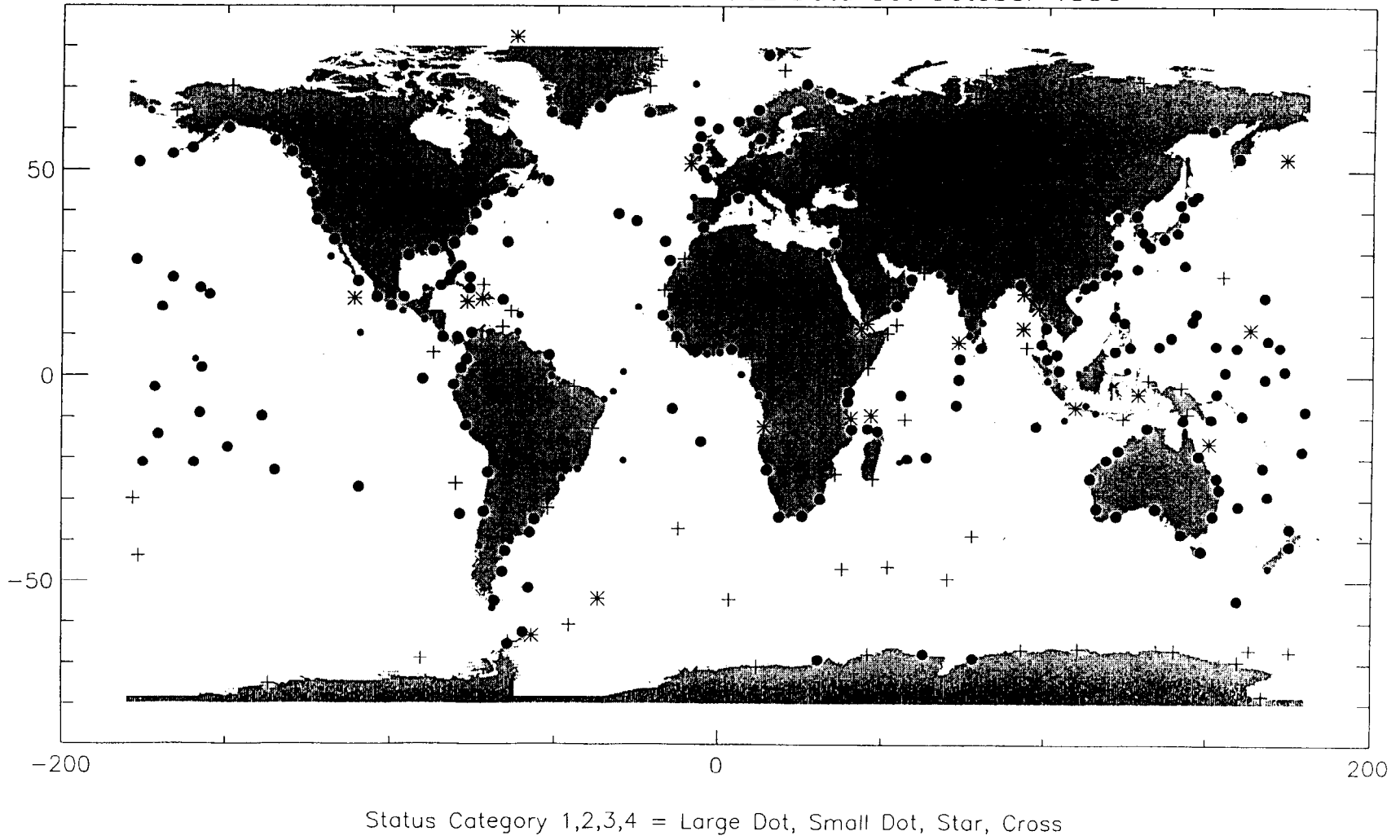

Figure 5.1

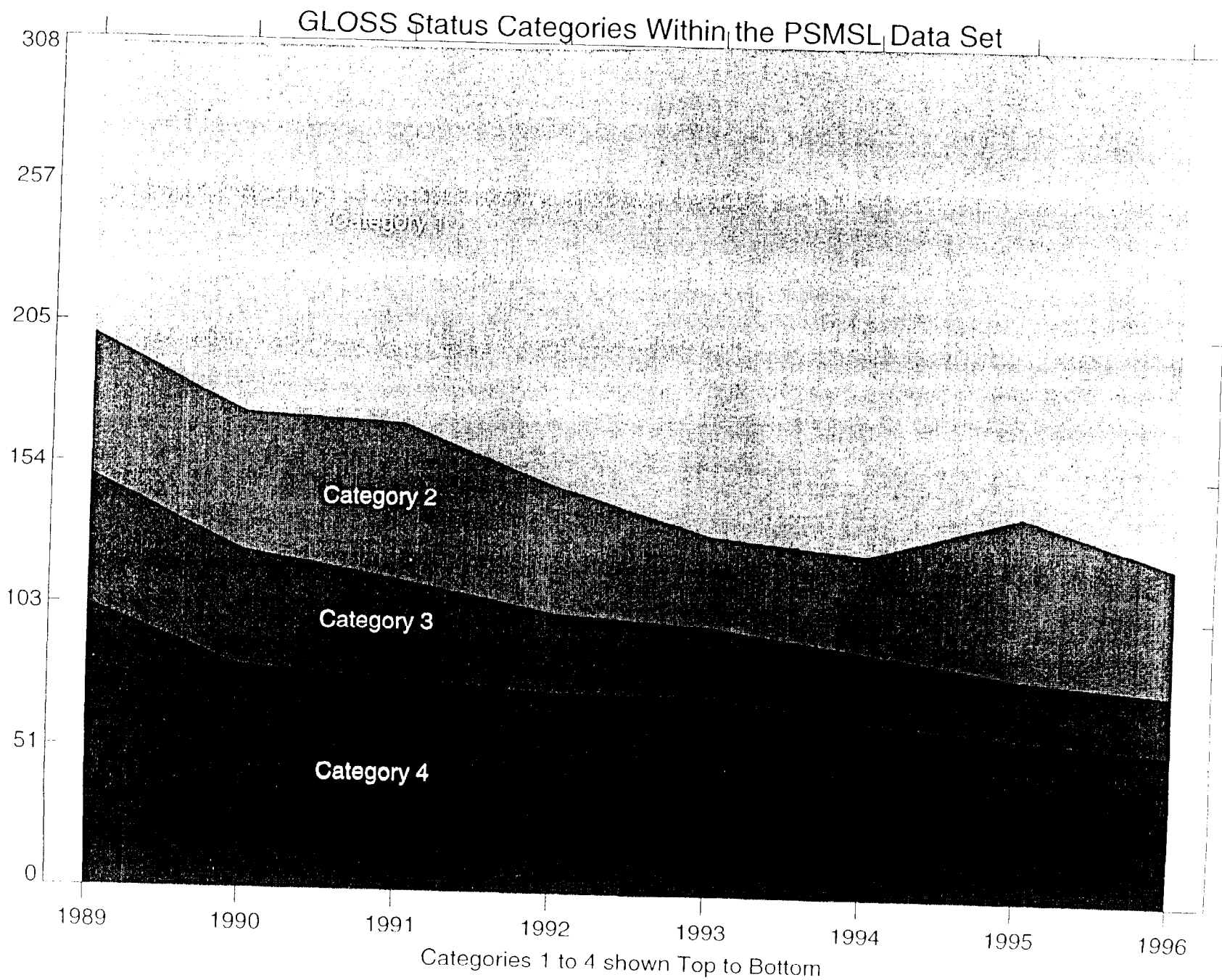

Figure 5 2

Categories 1 to 4 shown Top to Bottom

GLOSS Operational Stations February 1995

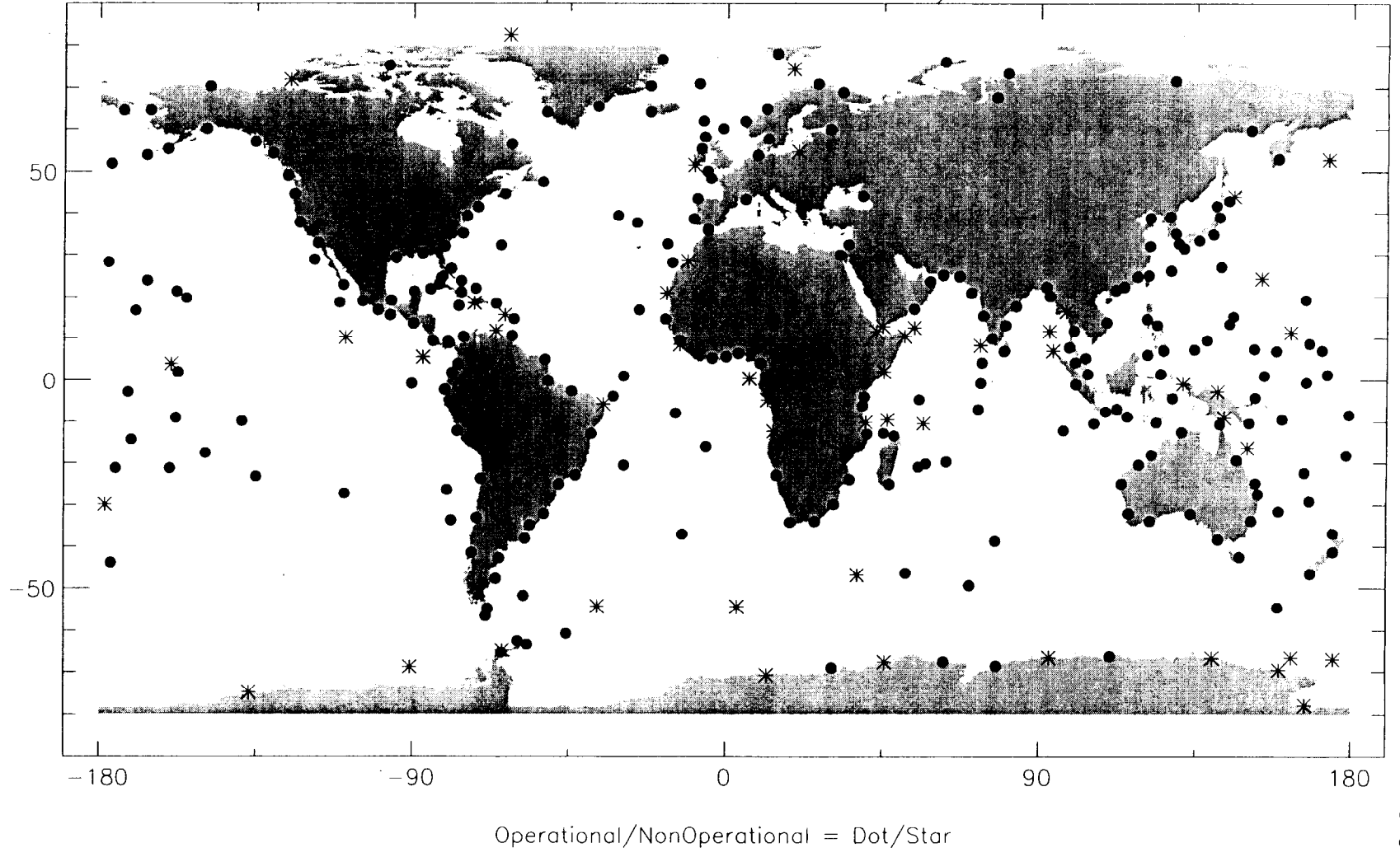

Figure 5.3

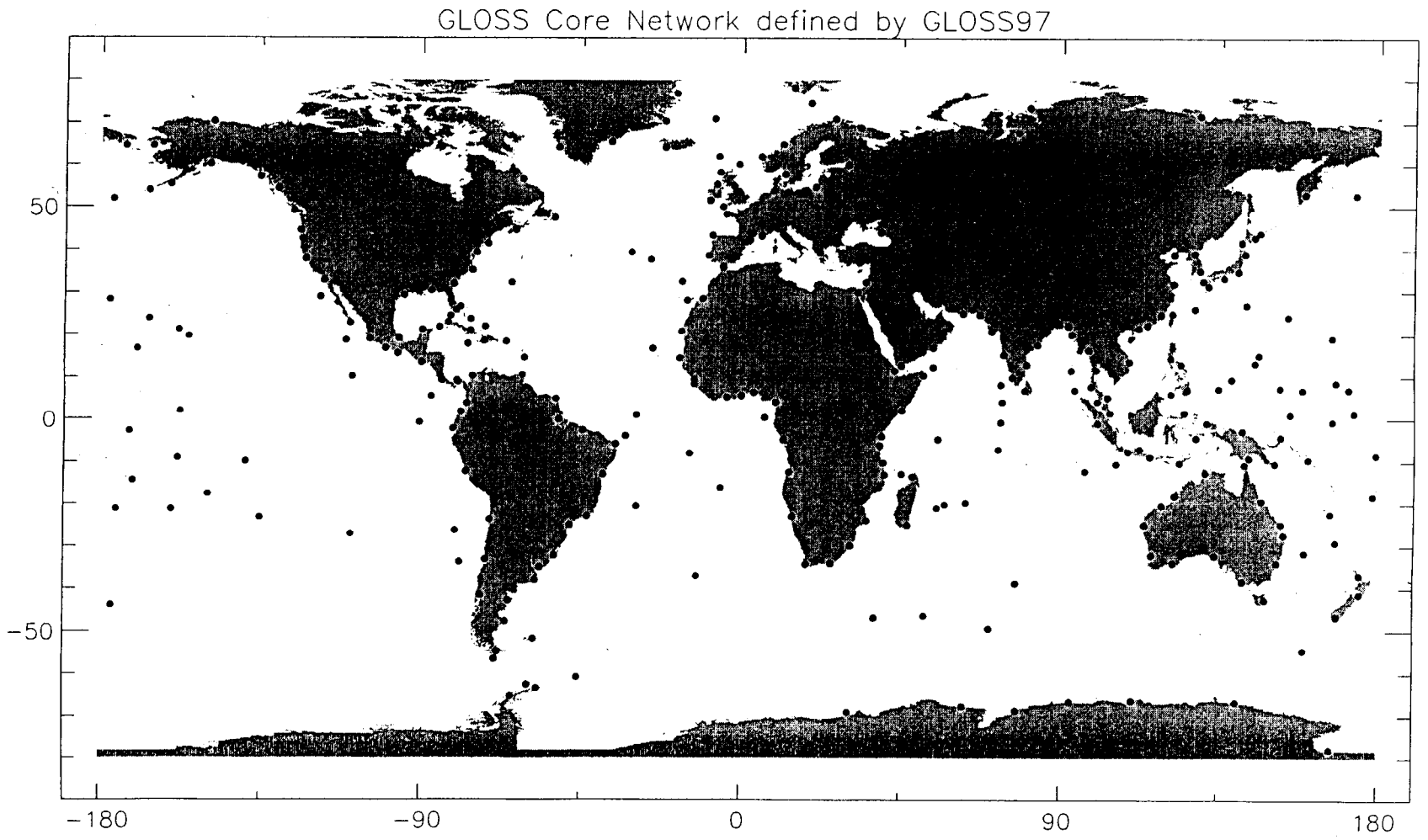
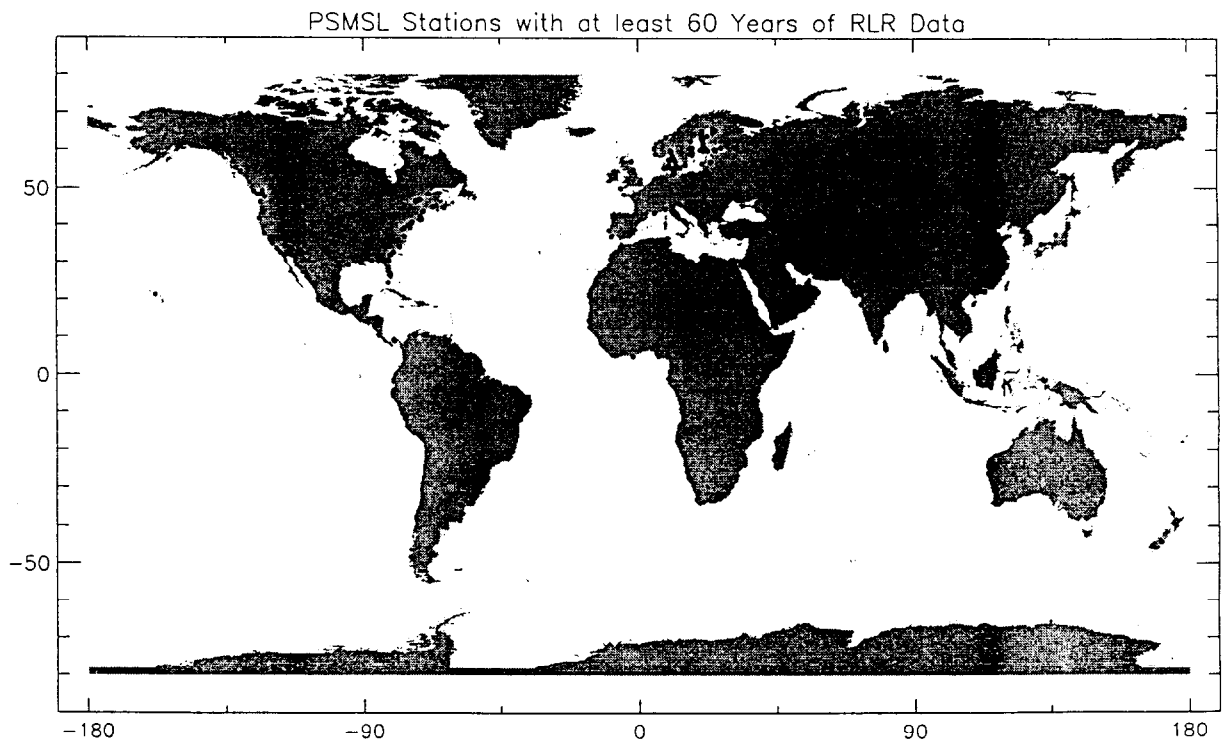
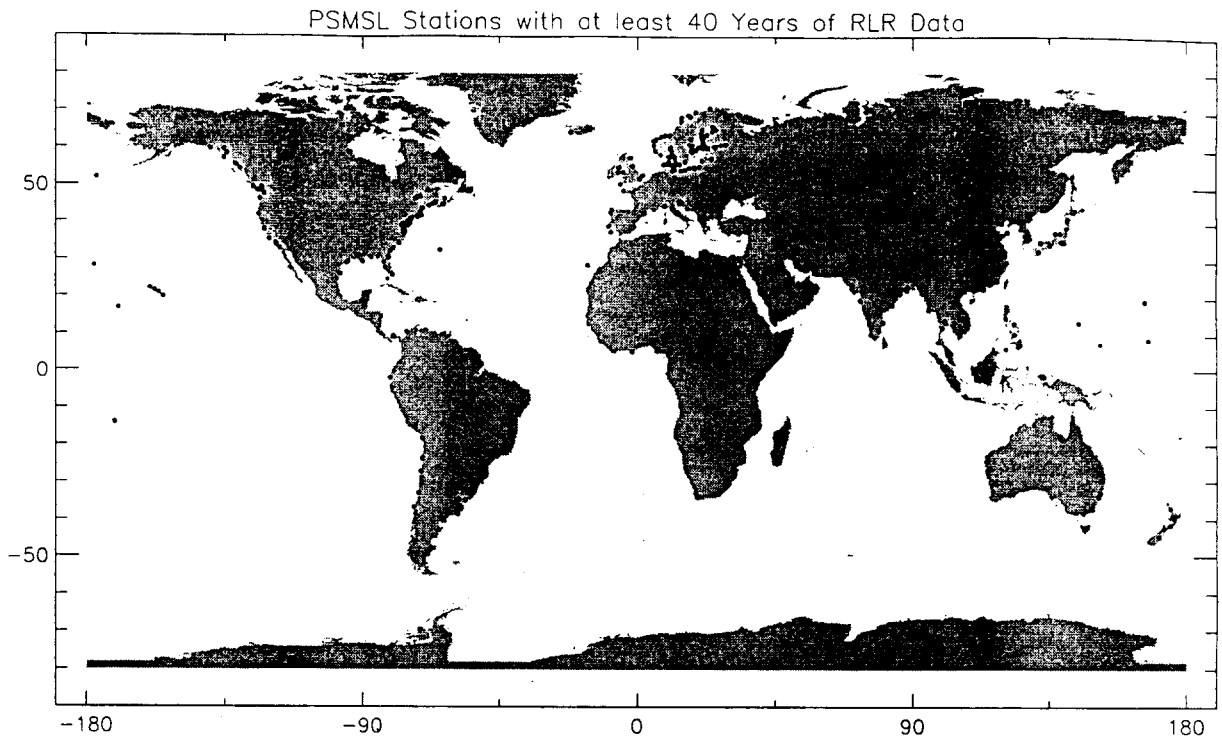

Figure 5.4



Figures 5.5 a,b

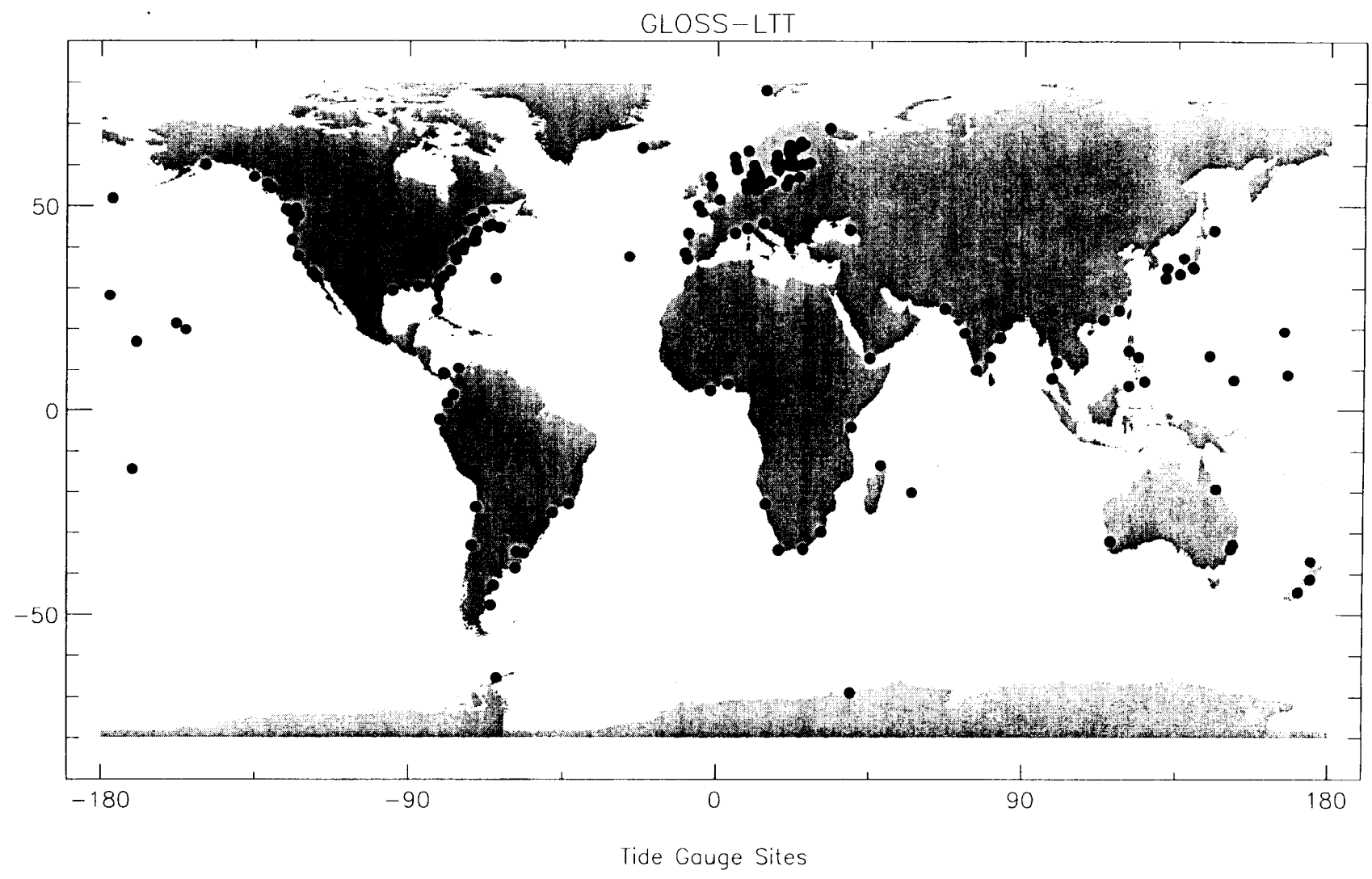

Figure 5.6

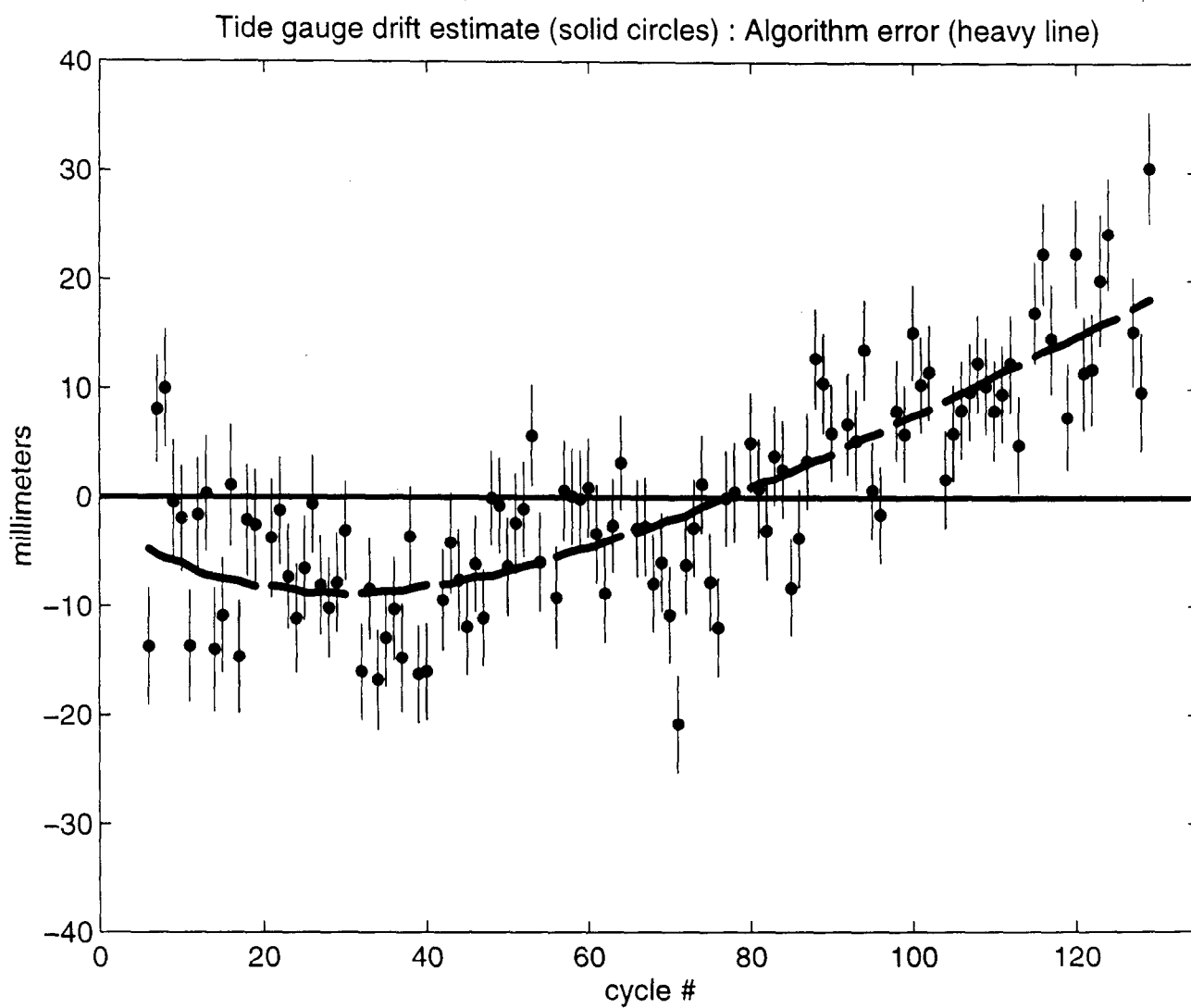

Figure 5.7

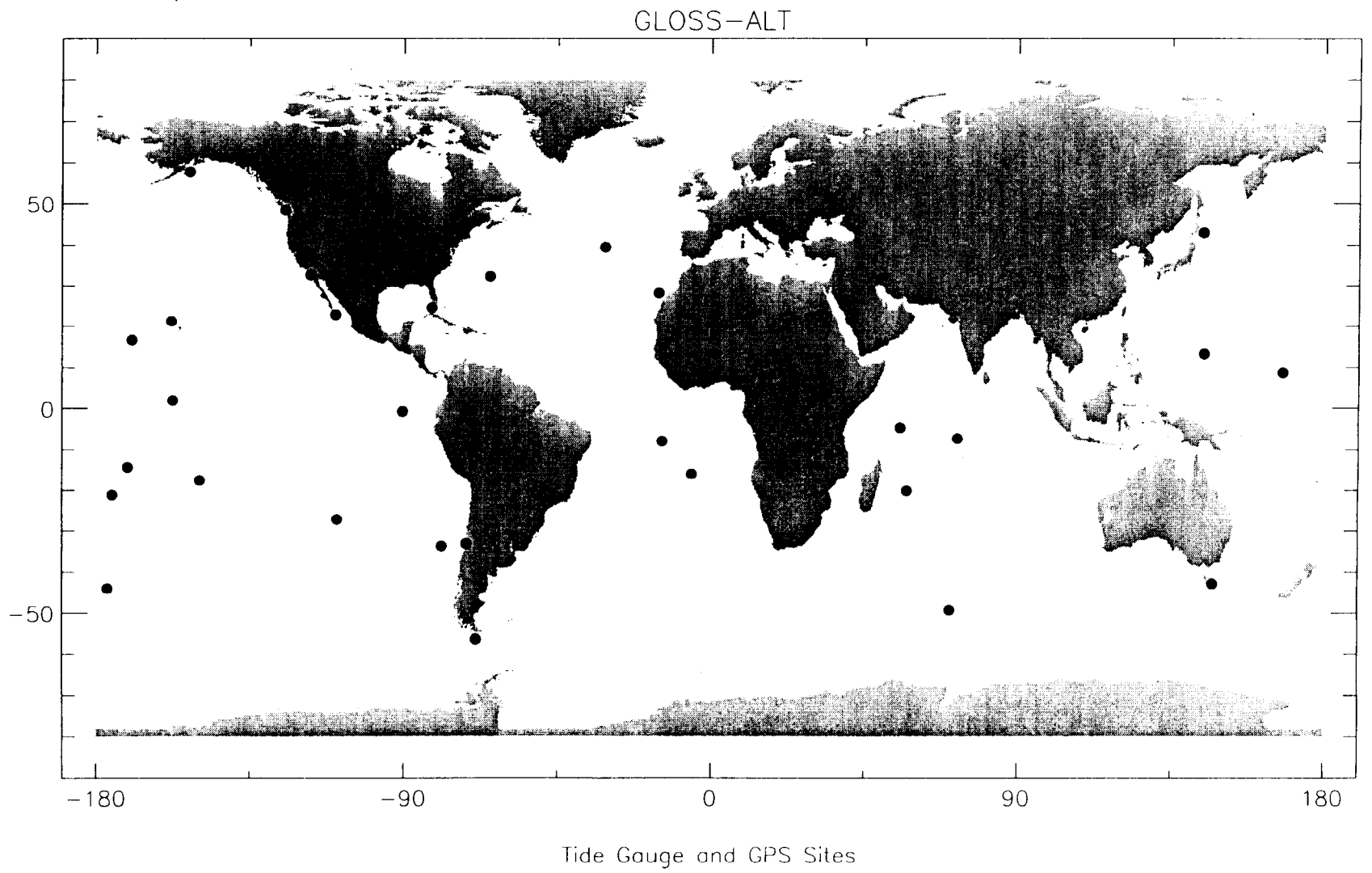
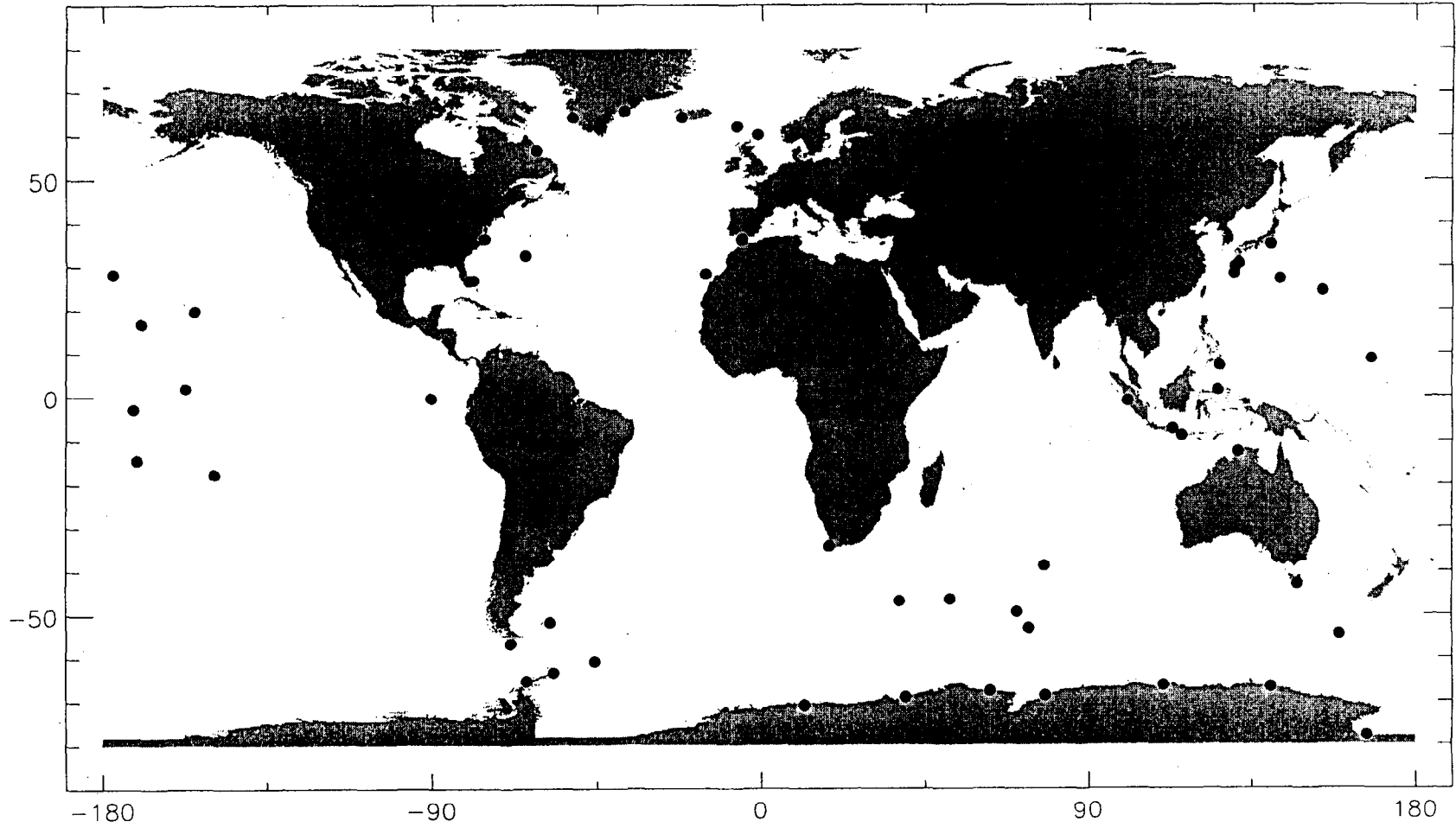

Figure 5.8

GLOSS-OC



Tide Gauge Sites (not incl. Caribbean).

Figure 5.9

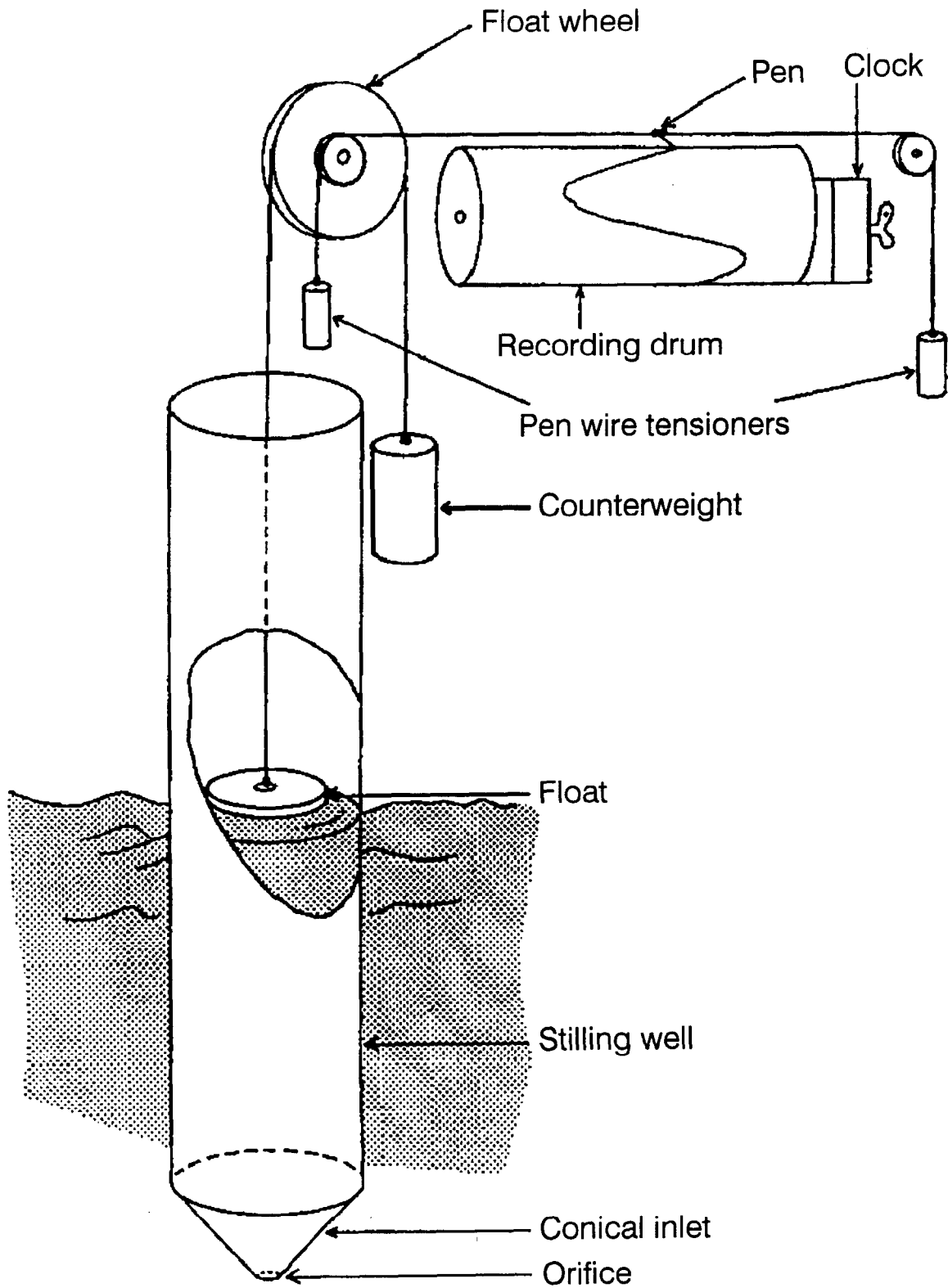
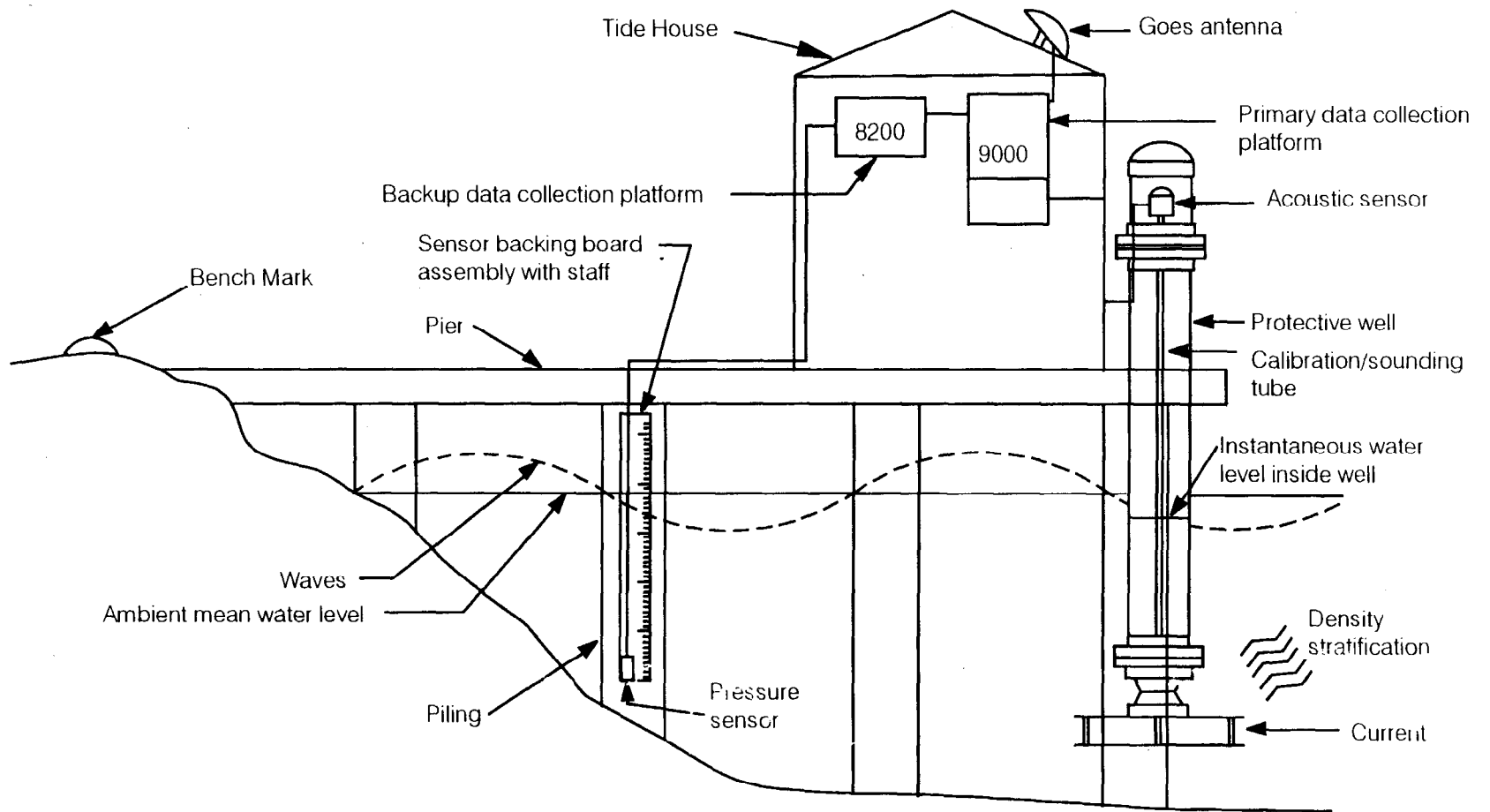

Figure 6.1

Figure 6.2



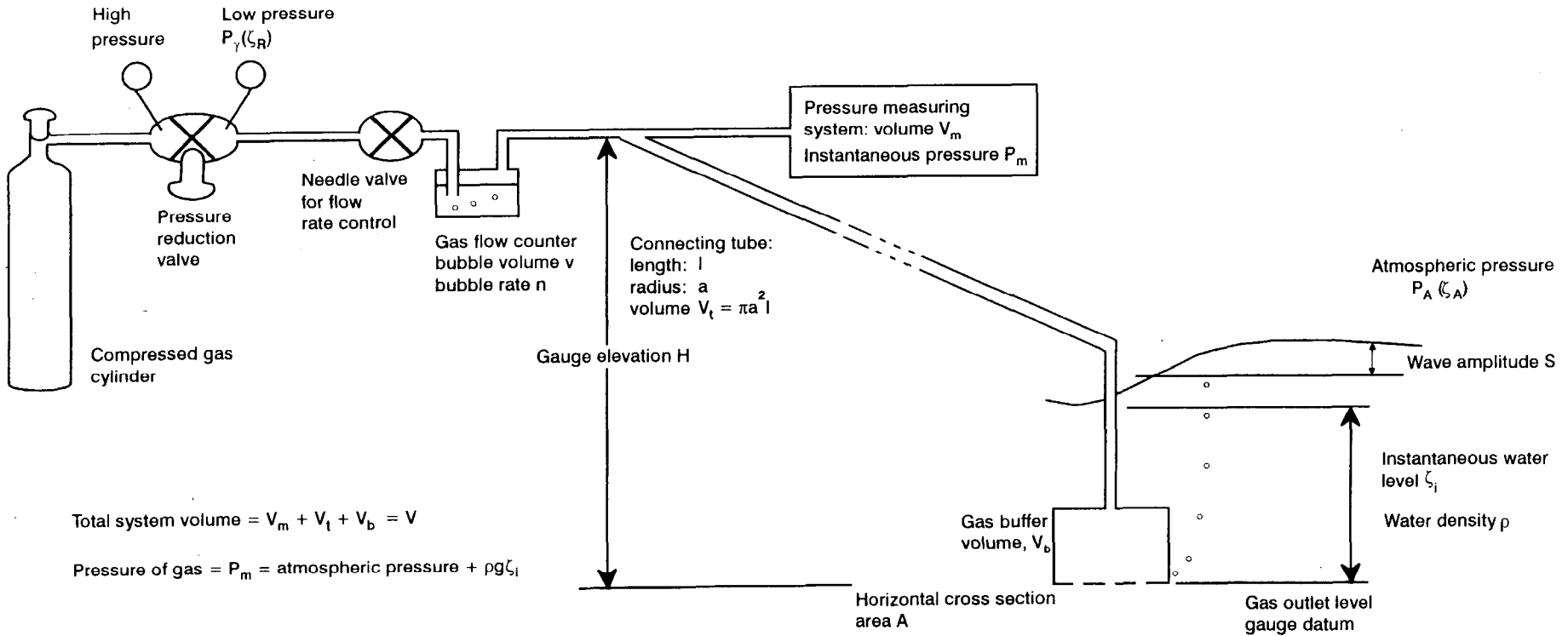

Figure 6.3

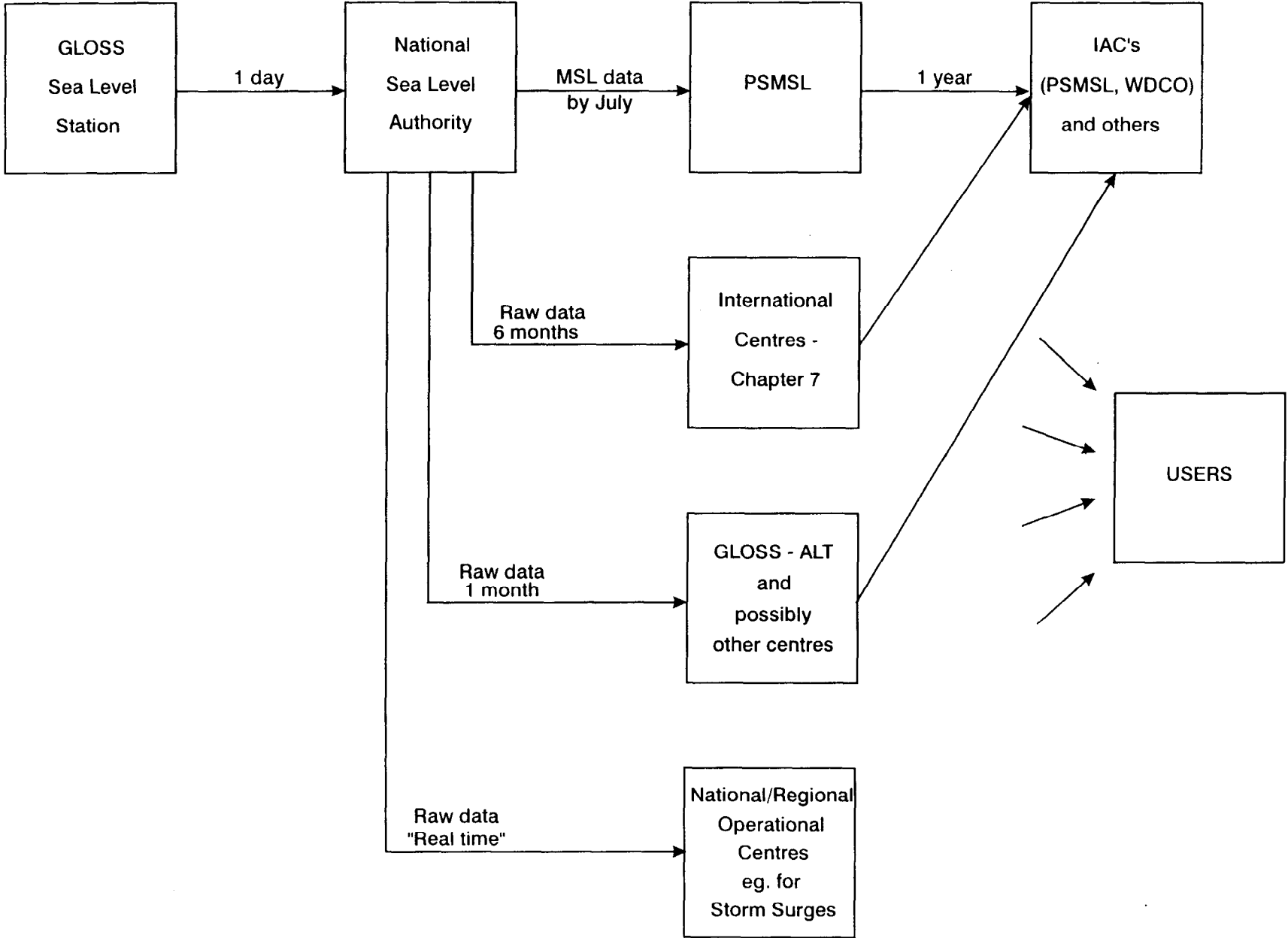

Figure 7.1

GLOBAL STATIONS† International GPS Service for Geodynamics



Figure 7.2

† Processed by three or more IGS Analysis Centers, one of which is on another continent

June 1996

Distribution of PSMSL Stations

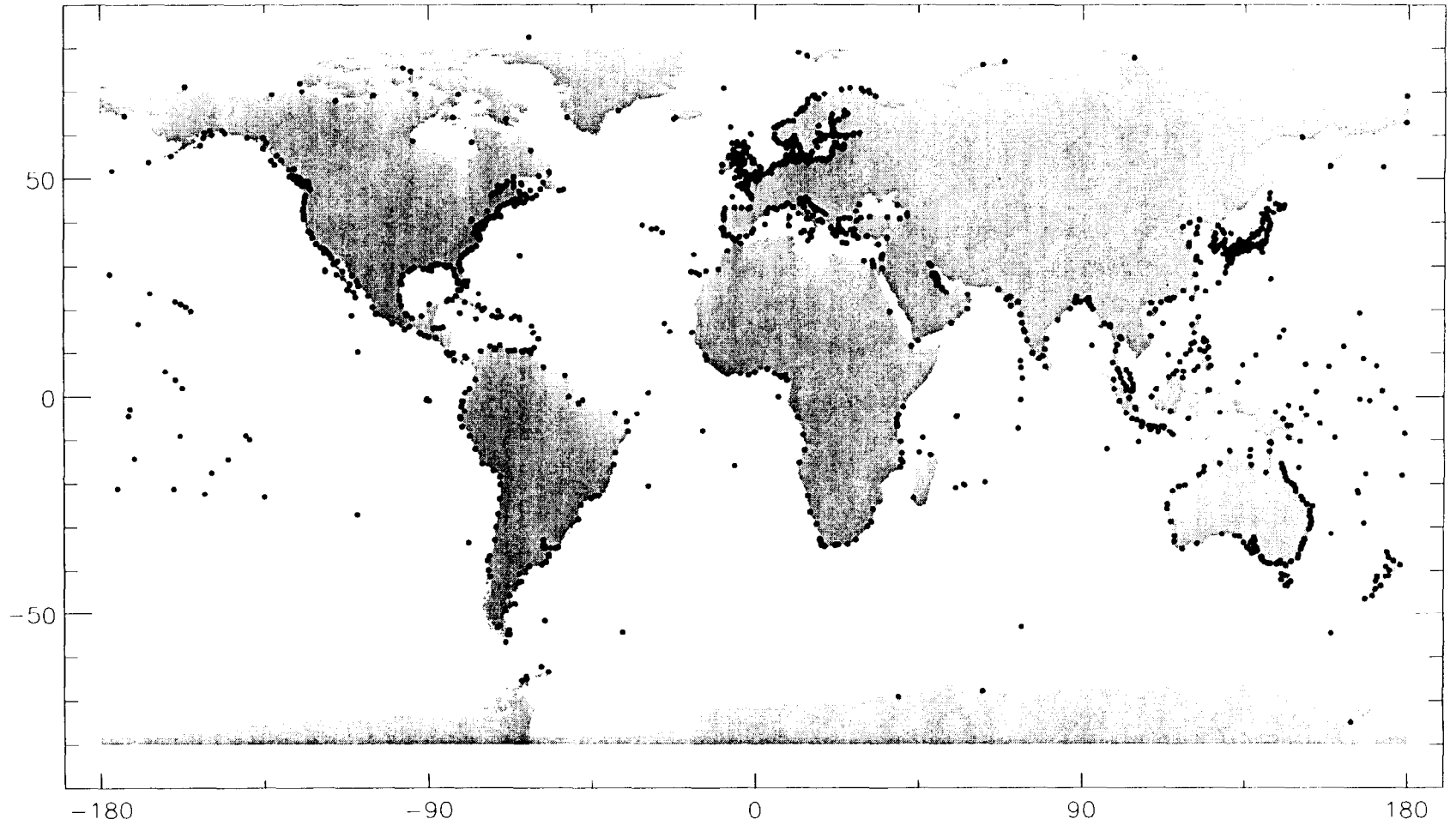
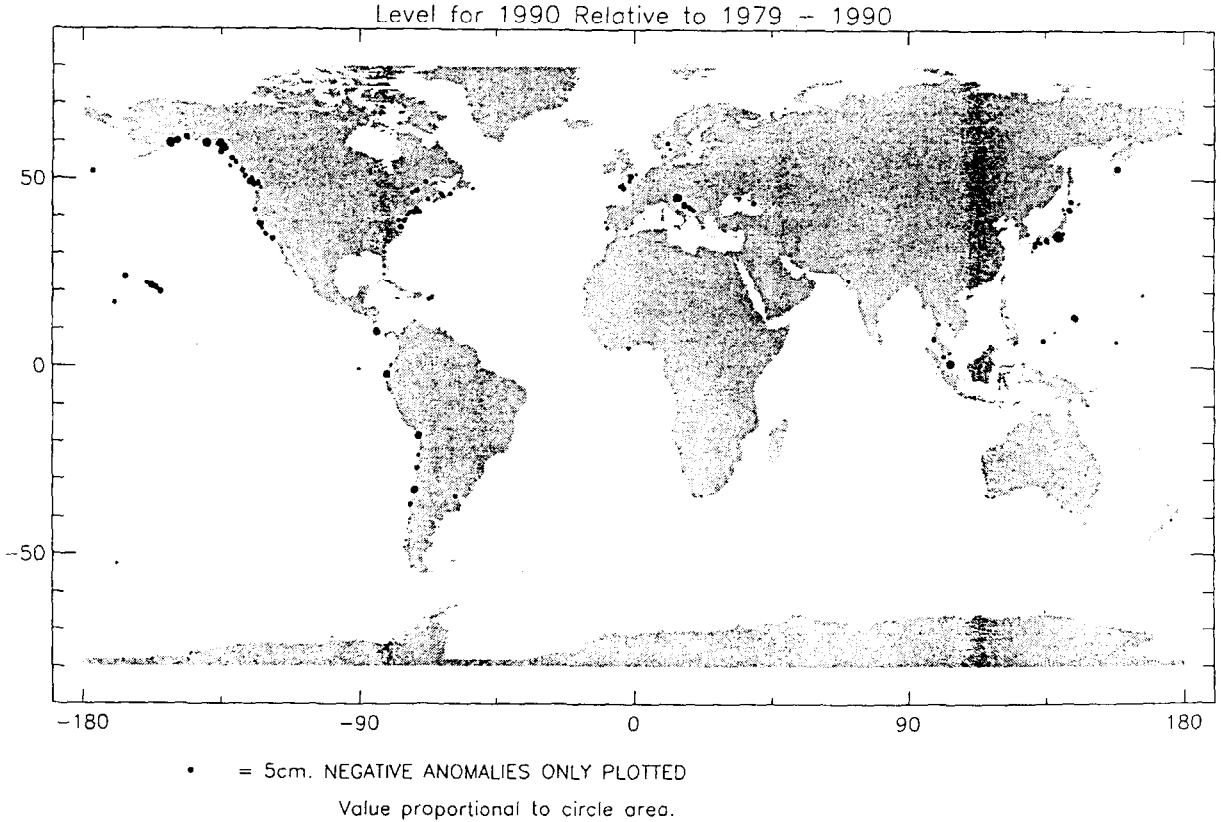
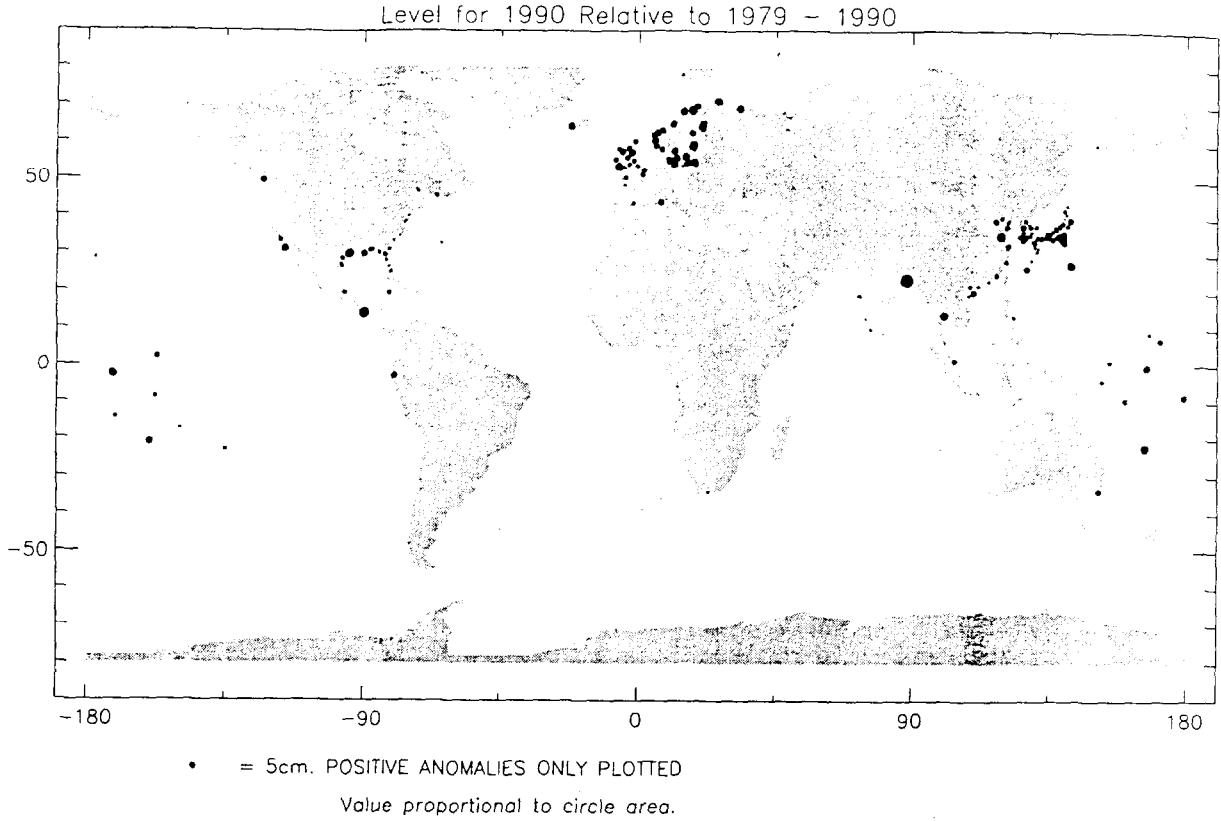
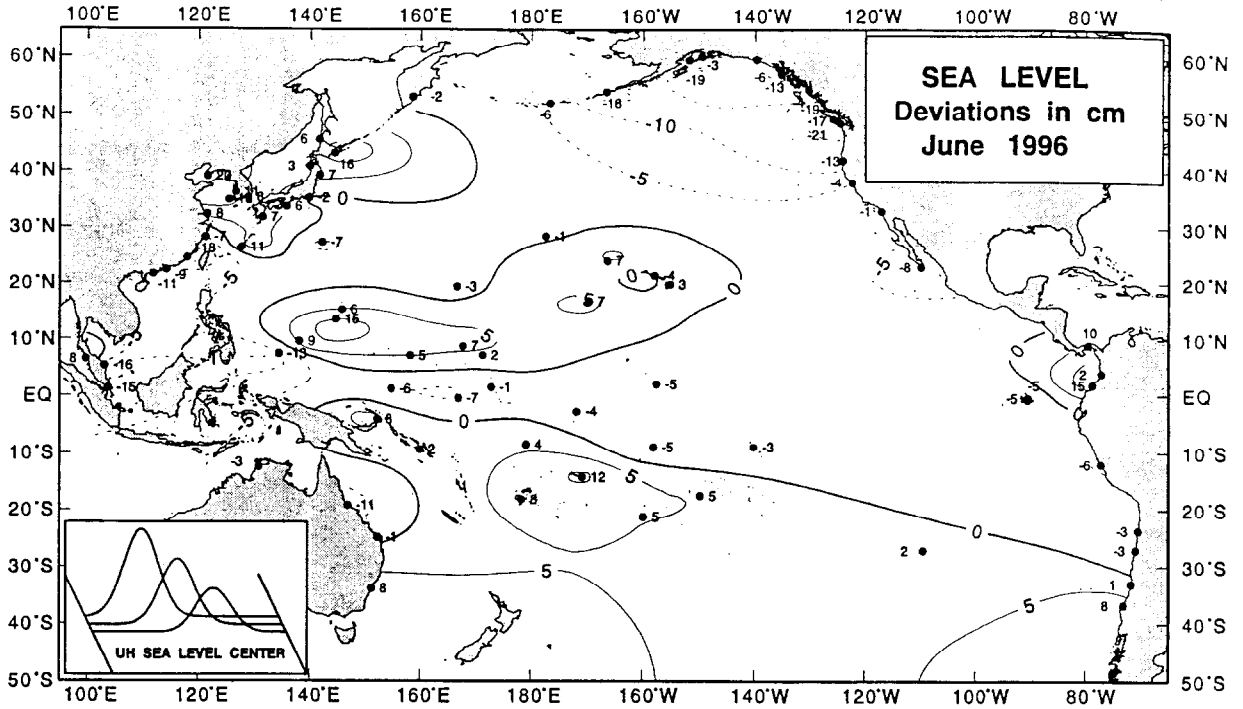

Figure 8.1



Figures 8.2 a,b



Deviation of sea level from the 1975 to 1986 mean sea level.

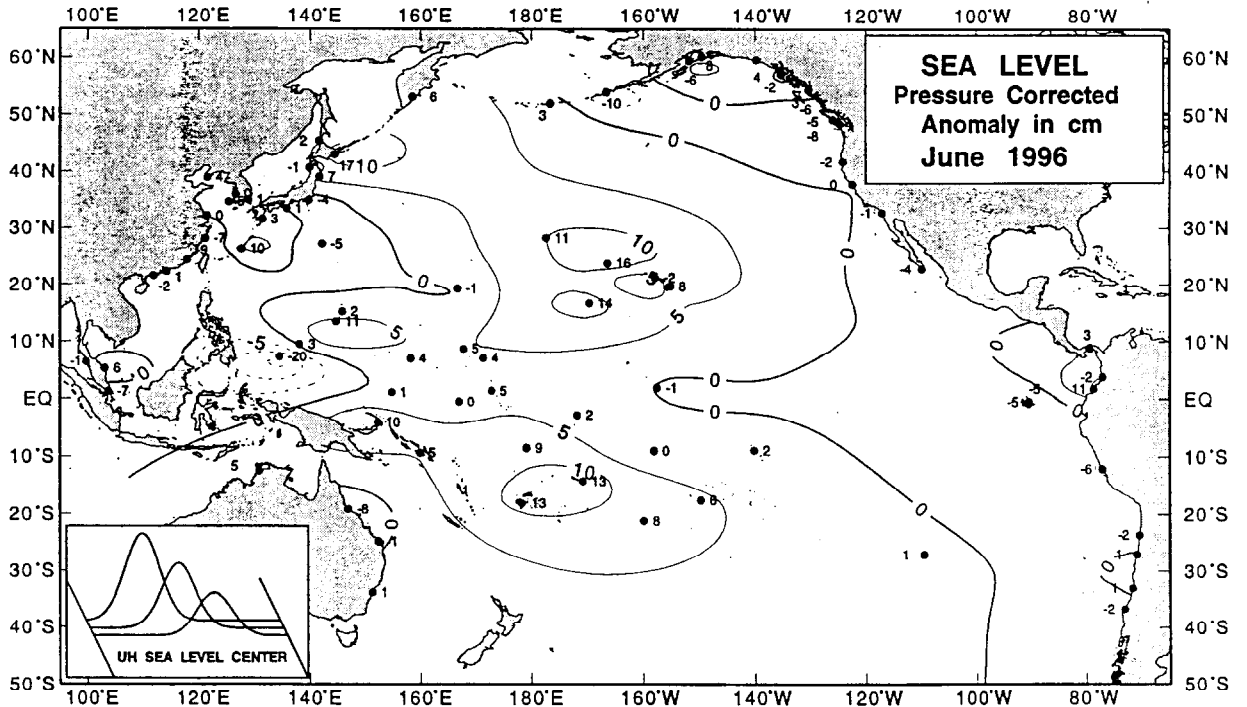

Anomaly of sea level from the 1975 to 1986 mean sea level adjusted for atmospheric pressure.

Figures 8.3 and 8.4

South Pacific Sea Level & Climate Monitoring Project and Australian Baseline Array Monitoring Sites

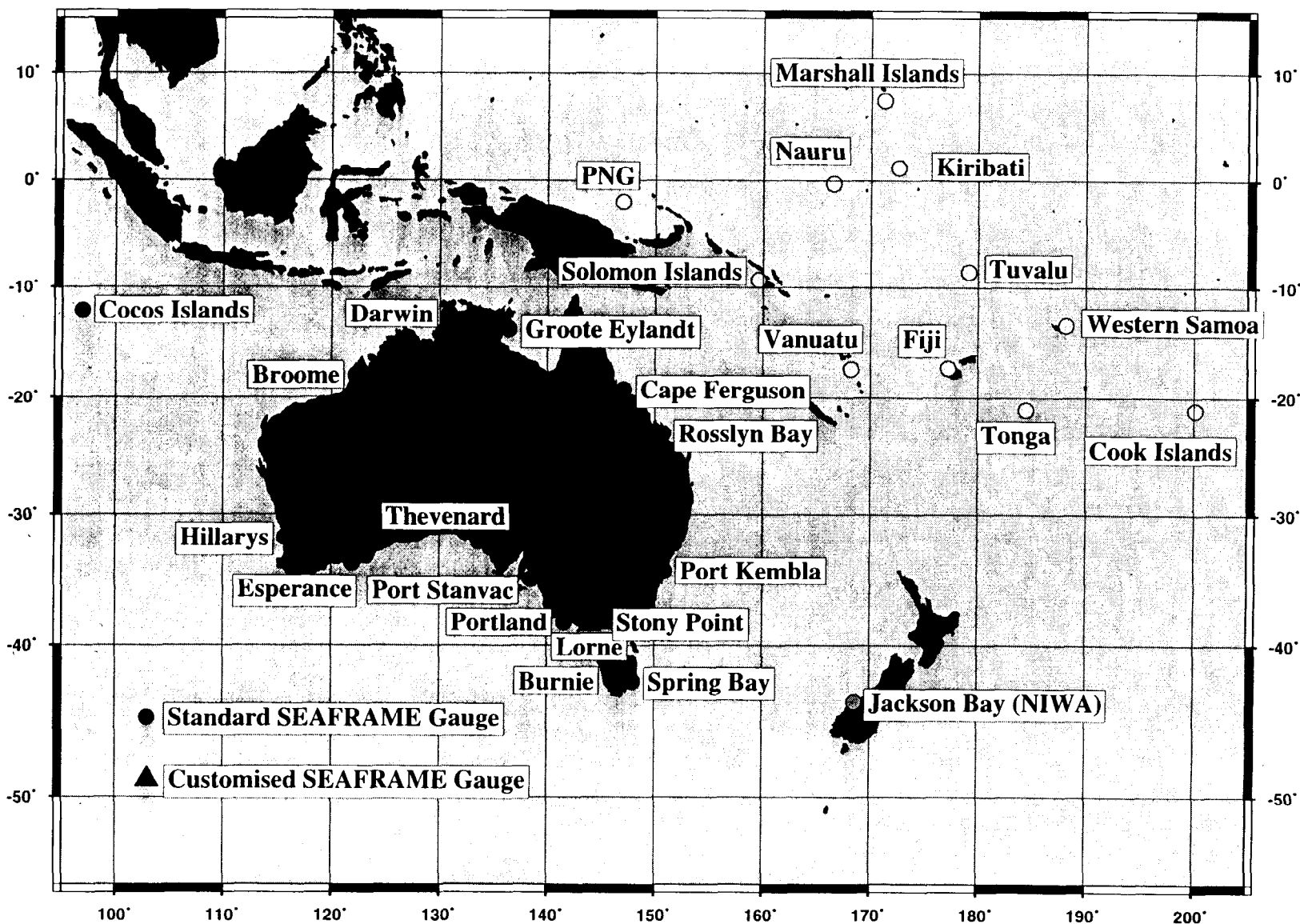

Figure 8.5

SOUTHERN OCEAN SEA LEVEL STATIONS

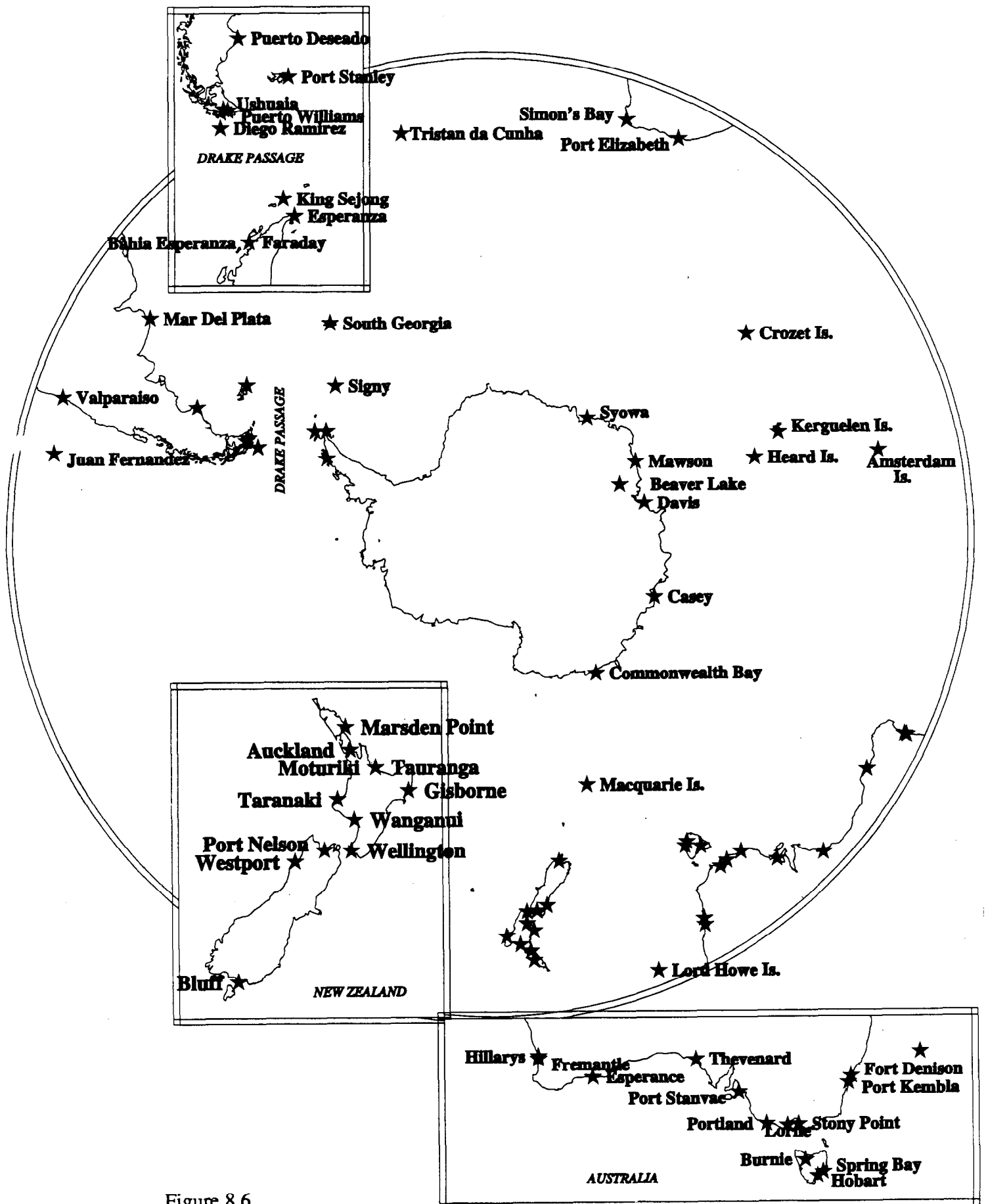

Figure 8.6

Topex/Poseidon Quarterly Altimeter Analysis

Bob Cheney, Nancy Doyle, and John Lillibridge

National Ocean Service, NOAA (N/OES11)
Silver Spring, MD 20910

The map below shows sea level *anomaly* for the spring quarter (Mar-Apr-May) 1996. Annual and semiannual signals have been removed, leaving only the interannual change relative to the 3-year 1993-95 mean. The complete Topex NOAA analysis for 1992-96 is available via internet on anonymous ftp at "harpo.grdl.noaa.gov" (IP# 140.90.158.129). Under directory pub, see subdirectories topex, topex_monthly_dev, and topex_monthly_anom. For those with access to mosaic software and the world-wide web, monthly Topex/Poseidon sea level deviation and anomaly maps can be displayed in color at URL "<http://www.grdl.noaa.gov/SAT/products/topex.html>".

Sea Level Anomaly

Spring 96

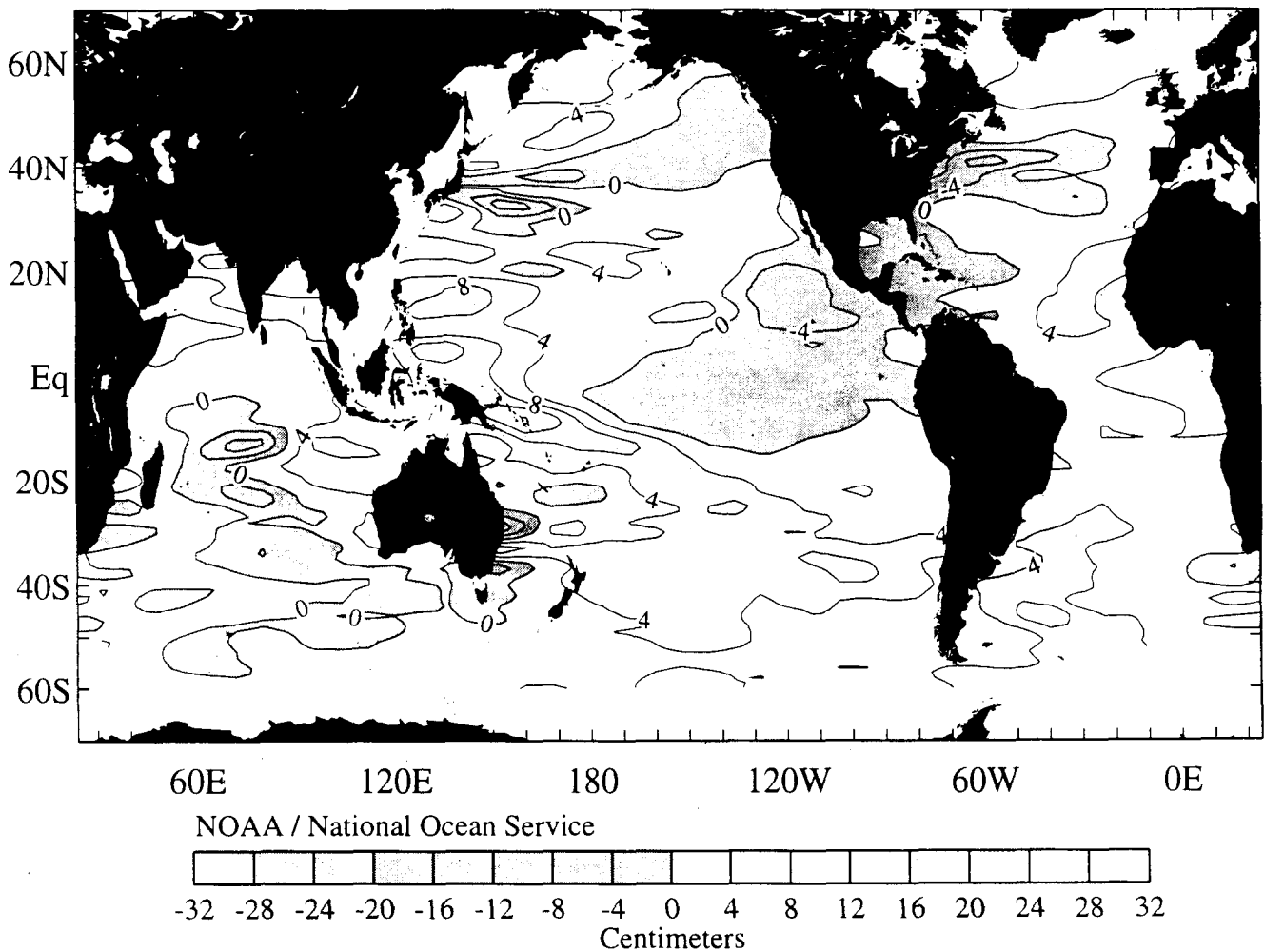

Figure 8.7

Euro-GLOSS and EPTN Networks

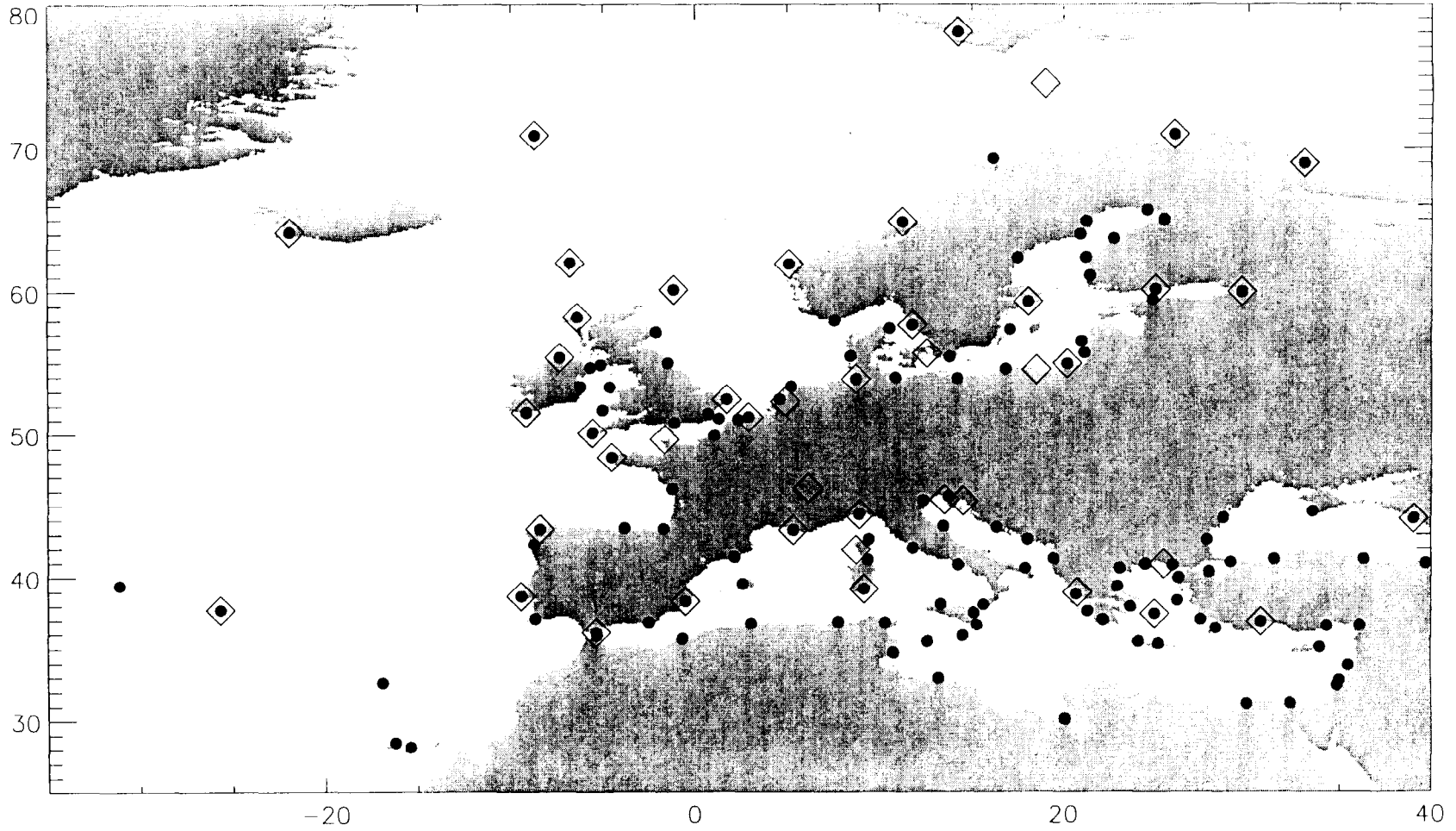

Figure 9.1

Pacific Tsunami Warning System

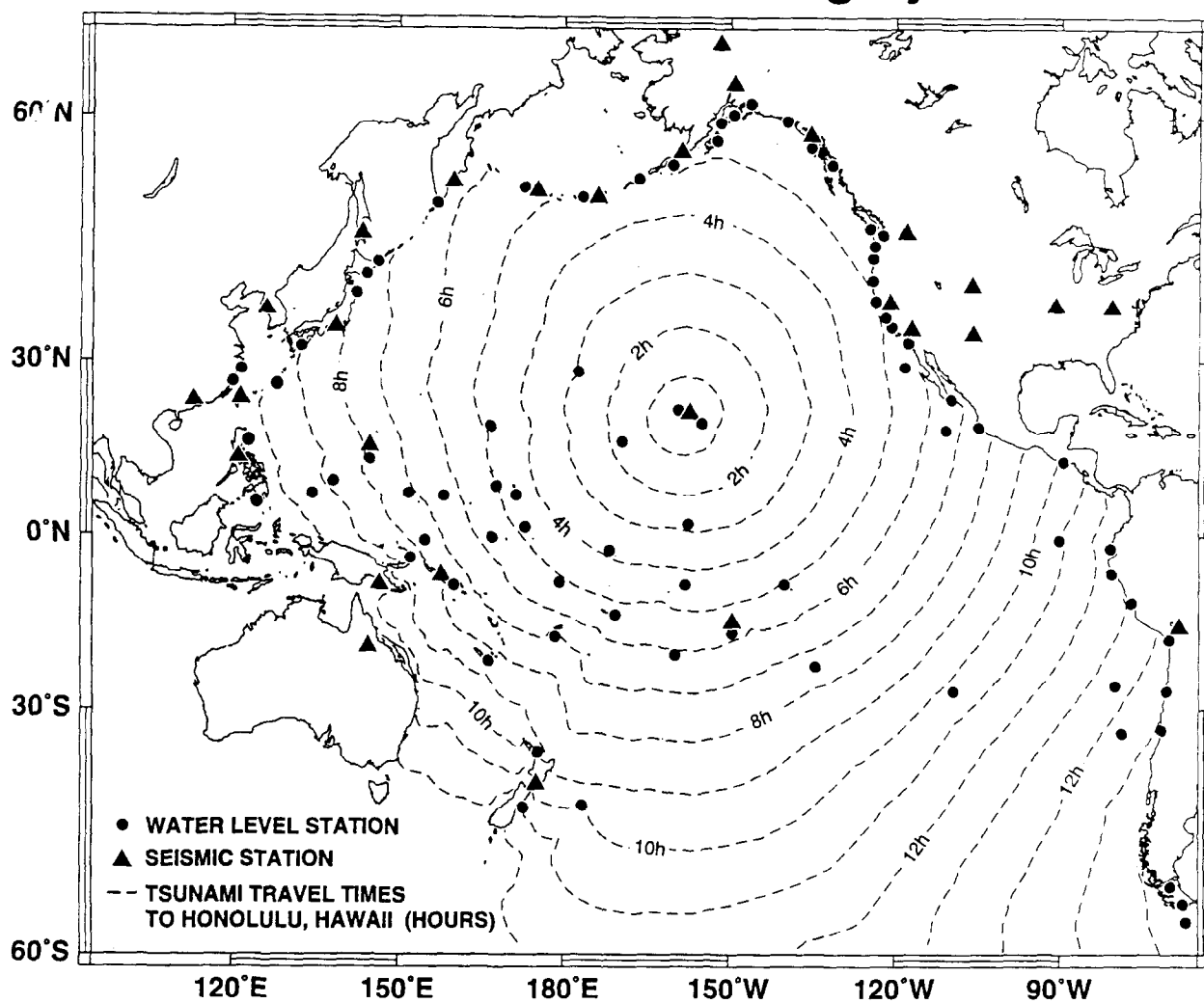
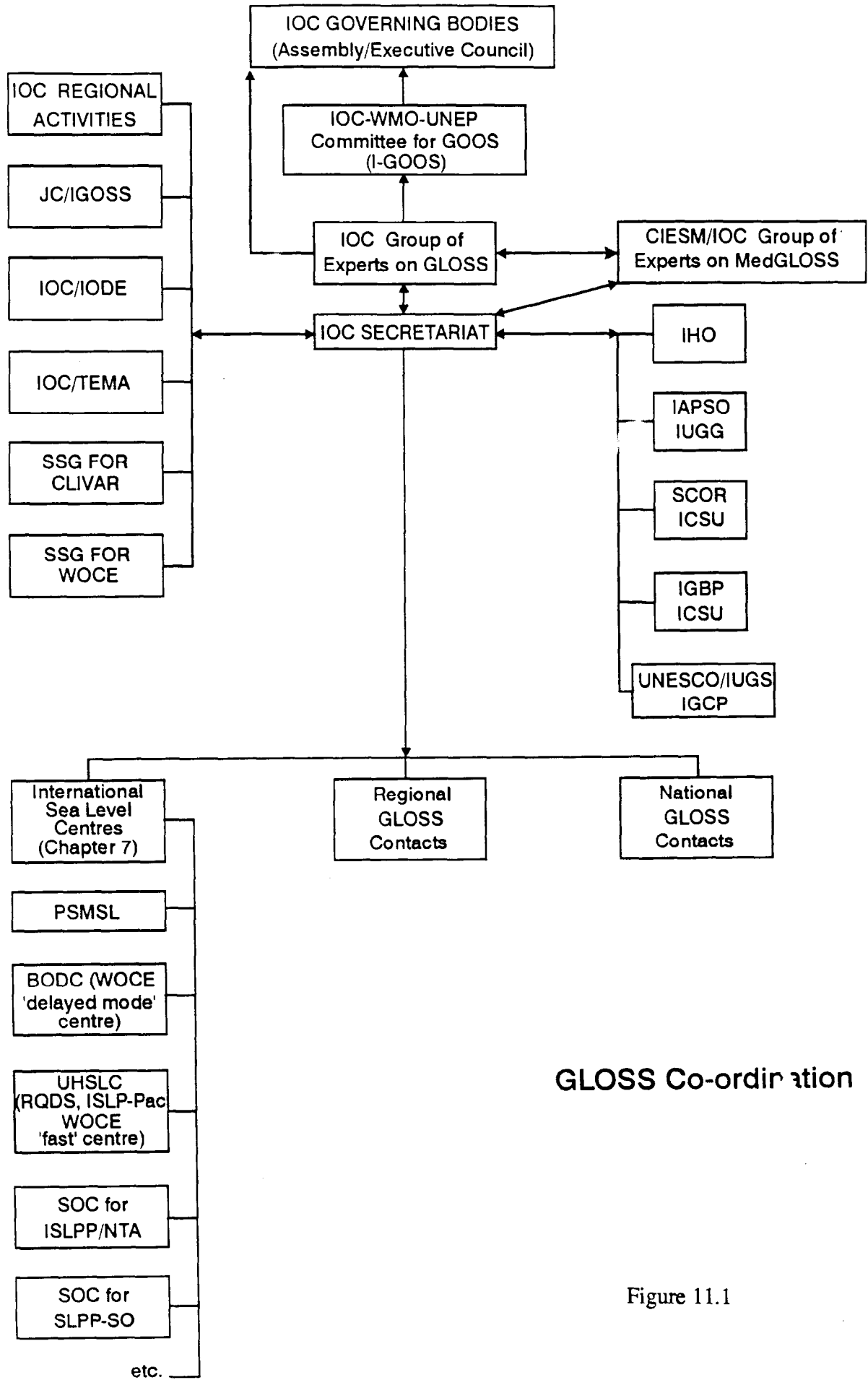

Figure 9.2



GLOSS Co-ordination

Figure 11.1

ANNEX I

INTERGOVERNMENTAL OCEANOGRAPHIC COMMISSION
QUESTIONNAIRE ON COMMITMENT TO THE GLOBAL SEA LEVEL OBSERVING
SYSTEM

Please complete one copy of the questionnaire for each GLOSS station, or group of stations, as necessary.

Date

Country

Name(s) of Station(s)

Latitude(s)

Longitude(s)

Is this gauge(s) to be considered "Committed to GLOSS"? That is to say, will best efforts will be made to provide and exchange sea level data in accordance with the methods described in Chapter 7 of the GLOSS Implementation Plan?

If yes, please answer the following questions to aid GLOSS planning.
If no, please explain, why not? (Replies will not be circulated).

Is the gauge(s) in operation or not?

Is assistance required to make the gauge(s) fully operational?
If yes, what sort of assistance?

If the gauge(s) is operational:

Is sea level recorded on paper charts?
Or transmitted electronically to a data centre?
Or stored locally on a data logger?
Or what?

Regarding raw tide gauge data (e.g. hourly values):

Will you be able to make (QC'd or unQC'd) raw tide gauge data available, either to a Centre or via your own server with six monthly updates, as specified in Chapter 7 of the Implementation Plan?

Which method of making them available to the community will you use?

If an International Centre required faster access to these raw data, how soon could they (presumably unQC'd) be made available either to the Centre, or placed on your own FTP server?

Regarding MSL data:

Can monthly MSL data (quality controlled) be sent to the PSMSL by July of the year following the data-year?
If not, what is the likely delay, and what is the reason for the delay?

Do institutes in your country use any of the altimeter data, or tide gauge or altimeter products described in the Implementation Plan?

If yes, do you have comments on any of them?

Would you like further information on any of the products? If yes, which?

IOC Technical Series No. 50

Annex I - page 2

Which global and regional programmes described in the Implementation Plan does your country participate in?

What are your sea level-related contributions to these programmes and how might they be enhanced?

What are the requirements for GLOSS-related training in your country?

How should the GLOSS programme evolve from your point of view?

Many thanks. Please add your name, address and contact numbers.

ANNEX II

STATUS OF SEA LEVEL DATA AVAILABILITY IN GLOSS

Status is defined by GLOSS93. Table includes in columns 6-8 a statement of the most recent data submitted to the PSMSL from GLOSS stations as of October 1996.

Column 1 = GLOSS NUMBER
 Column 2 = GLOSS SITE NAME
 Column 3 = RESPONSIBLE COUNTRY DEFINED BY 1990 IMPLEMENTATION PLAN
 Column 4 = COMMITTED TO GLOSS FLAG DEFINED BY 1990 IMPLEMENTATION PLAN
 ('C' INDICATES THAT THE STATION IS COMMITTED)
 Column 5 = ACTIVE/INACTIVE STATUS REPORTED IN 1995 SURVEY OF GLOSS93
 ('I' INDICATES INACTIVE)
 Column 6/7 = PSMSL COUNTRY/STATION CODE OF LATEST DATA
 Column 8 = YEAR OF LATEST PSMSL DATA
 Column 9 = * INDICATES STATION NOT INCLUDED IN GLOSS97 (SECTION 5.1.2)

262	LOBITO	ANGOLA	I	426/021	1975
185	BAHIA ESPERANZA	ARGENTINA	C	A /001	1978
192	MAR DEL PLATA	ARGENTINA	C	860/101	1994
190	PUERTO DESEADO	ARGENTINA	C	860/011	1994
191	PUERTO MADRYN	ARGENTINA	C	860/031	1994
181	USHUAIA	ARGENTINA	C	860/002	1994
61	BOOBY IS.	AUSTRALIA	C	680/025	1994
58	BRISBANE	AUSTRALIA	C	680/078	1994
40	BROOME	AUSTRALIA	C	680/497	1994
59	BUNDABERG	AUSTRALIA	C	680/073	1994
52	CARNARVON	AUSTRALIA	C	680/479	1994
278	CASEY	AUSTRALIA	C		
47	CHRISTMAS IS.	AUSTRALIA	C	563/001	1991
46	COCOS IS. (KEELING)	AUSTRALIA	C	680/521	1994
62	DARWIN	AUSTRALIA	C	680/011	1994
277	DAVIS	AUSTRALIA	C	A /046	1994
54	ESPERANCE	AUSTRALIA	C	680/446	1994
53	FREMANTLE	AUSTRALIA	C	680/471	1994
148	LORD HOWE IS.	AUSTRALIA	C	680/123	1994
130	MACQUARIE IS.	AUSTRALIA	C	680/208	1995
22	MAWSON	AUSTRALIA	C	A /051	1995
124	NORFOLK IS.	AUSTRALIA	C	680/091	1994
51	PORT HEDLAND	AUSTRALIA	C	680/494	1994
55	PORTLAND	AUSTRALIA	C	680/231	1994
56	SPRING BAY	AUSTRALIA	C	680/199	1994
57	SYDNEY, FORT DENISON	AUSTRALIA	C	680/141	1993
308	THEVENARD	AUSTRALIA	C	680/441	1994
60	TOWNSVILLE	AUSTRALIA	C	680/051	1994
279	WILLIS IS.	AUSTRALIA	C	I 680/039	1981 *
12	EXUMA	BAHAMAS	C	941/021	1993
211	SETTLEMENT POINT	BAHAMAS	C	941/001	1995
36	CHITTAGONG	BANGLADESH		510/008	1994
120	MALAKAL	BELAU	C	711/021	1995
194	CANANEIA	BRAZIL	C	874/051	1986
198	FERNANDA DE NORONHA	BRAZIL	C	874/143	1985
196	ITAPARICA	BRAZIL	C		
200	PONTA DA MADEIRA	BRAZIL	C		
197	PORTO DE NATAL	BRAZIL	C	I 874/133	1985
193	PORTO DE RIO GRANDE	BRAZIL	C		
201	PORTO DE SANTANA	BRAZIL	C	874/171	1984
195	RIO DE JANEIRO	BRAZIL	C	874/092	1991
199	ST. PETER & ST. PAUL ROCKS	BRAZIL		874/147	1985
265	TRINIDADE IS.	BRAZIL	C	874/102	1983
280	DOUALA	CAMEROON			
226	ALERT	CANADA	C	I 970/162	1977 *
222	HALIFAX	CANADA	C	970/011	1994
153	LITTLE CORNWALLIS IS.	CANADA	C	970/156	1994

IOC Technical Series No. 50

Annex II - page 2

224	NAIN	CANADA	C	970/134	1988
155	PRINCE RUPERT	CANADA	C	822/001	1994
152	SACHS HARBOUR	CANADA	C I	970/203	1982 *
223	ST. JOHNS, NEWFLND.	CANADA	C	970/121	1994
156	TOFINO	CANADA	C	822/116	1994
254	PORTO GRANDE (ST. VICENTE)	CAPE VERDE	C	380/002	1990
174	ANTOFAGASTA	CHILE	C	850/012	1995
189	CAPTAIN PRAT (ANTARCTICA)	CHILE	C A	/005	1995
180	DIEGO RAMIREZ	CHILE	C	850/091	1991
176	JUAN FERNANDEZ IS.	CHILE	C	850/039	1995
137	PASCUA IS.	CHILE	C	810/003	1995
178	PUERTO MONTT	CHILE	C	850/051	1991
177	SAN FELIX IS.	CHILE	C		
175	VALPARISO	CHILE	C	850/032	1995
94	KANMEN	CHINA, PEOPLE'S REP.	C	610/016	1994
79	LAOHUTAN (DALIAN)	CHINA, PEOPLE'S REP.	C	610/044	1992
283	LUSI	CHINA, PEOPLE'S REP.	C	610/032	1994
247	XIAMEN	CHINA, PEOPLE'S REP.	C	610/005	1994
78	ZHAPO	CHINA, PEOPLE'S REP.	C	610/002	1994
170	BUENAVENTURA	COLOMBIA	C	842/011	1995
207	CARTAGENA	COLOMBIA	C	902/021	1993
171	TUMACO	COLOMBIA	C	842/021	1995
261	POINTE NOIRE	CONGO	I	424/021	1988
143	PENRHYN	COOK ISLANDS	C	775/001	1995
139	RAROTONGA	COOK ISLANDS	C	785/001	1995
166	I. DEL COCO	COSTA RICA	I		
167	QUEPOS	COSTA RICA		836/011	1994
257	ABIDJAN	COTE D'IVOIRE	C	405/002	1988
214	CABO SAN ANTONIO	CUBA	C	930/071	1994
276	GIBARA	CUBA	C	930/031	1994
215	SIBONEY	CUBA	C	930/016	1995
228	ANGMAGSSALIK, GREENLAND	DENMARK	C	980/071	1992
227	DANMARKSHAVN, GREENLAND	DENMARK	C		
225	GODTHAB/NUUK, GREENLAND	DENMARK	C	980/031	1993
315	ITTOQQORTOORMIIT, GREENLAND	DENMARK	C		
237	TORSHAVN, FAEROES	DENMARK	C	015/011	1993
2	DJIBOUTI	DJIBOUTI	I	475/001	1972
169	BALTRA, GALAPAGOS IS.	ECUADOR	C	845/034	1994
172	LA LIBERTAD	ECUADOR	C	845/012	1994
1	SUEZ	EGYPT		330/041	1986
182	ACAJUTLA	EL SALVADOR		833/011	1991
117	KAPINGAMARANGI, CAROLINE IS.	FED. MICRONESIA	C	710/026	1995
115	PONAPE, CAROLINE IS.	FED. MICRONESIA	C	710/031	1995
116	TRUK, CAROLINE IS.	FED. MICRONESIA	C	710/001	1994
119	YAP, CAROLINE IS.	FED. MICRONESIA	C	710/011	1995
122	SUVA	FIJI	C	742/012	1995
242	BREST	FRANCE	C	190/091	1994
165	CLIPPERTON IS.	FRANCE	I	831/002	1988
21	CROZET IS.	FRANCE			
131	DUMONT D'URVILLE	FRANCE	I		
96	DZAODZI (MAYOTTE)	FRANCE	C	438/001	1995
23	KERGUELEN IS.	FRANCE			
204	LE ROBERT, MARTINIQUE	FRANCE	C	912/001	1984
205	MARSEILLE	FRANCE	C	230/051	1992
123	NOUMEA, NEW CALEDONIA	FRANCE	C	740/011	1995
142	NUKU HIVA, MARQUESAS IS.	FRANCE	C	805/011	1994
17	PTE DES GALETS, REUNION IS.	FRANCE	C	451/001	1986
24	ST. PAUL IS.	FRANCE			
202	CAYENNE, FRENCH GUIANA	FRENCH GUIANA		876/001	1993
140	PAPEETE, TAHITI	FRENCH POLYNESIA	C	780/011	1995
138	RIKITEA, GAMBIER IS.	FRENCH POLYNESIA	C	808/001	1995
284	CUXHAVEN	GERMANY	C	140/011	1986
258	TEMA	GHANA	C	410/016	1982
255	CONAKRY	GUINEA		396/001	1992
209	PORT-AU-PRINCE/LES GAYES	HAITI	I	934/011	1961
77	QUARRY BAY	HONG KONG	C	611/010	1995
229	REYKJAVIK	ICELAND	C	010/001	1995

IOC Technical Series No. 50
Annex II - page 3

32	COCHIN	INDIA	C	500/081	1990
34	MADRAS	INDIA	C	500/091	1990
281	MARMAGAO	INDIA		500/065	1990
29	MINICOY, LACCADIVE IS.	INDIA	C I	455/011	1977
41	NICOBAR	INDIA	I		
38	PORT BLAIR, ANDAMAN IS.	INDIA	I	540/001	1964
31	VERAVAL	INDIA	C	500/021	1983
35	VISHAKHAPATNAM	INDIA	C	500/101	1990
68	AMBON	INDONESIA	C	590/001	1931
49	BENOA	INDONESIA		560/135	1990
291	CILACAP	INDONESIA	C	560/121	1931
50	KUPANG, TIMOR	INDONESIA			
69	MANADO (BITUNG)	INDONESIA		580/012	1990
45	PADANG (TELU BAYUK)	INDONESIA		560/032	1990
67	SORONG	INDONESIA	I		
292	SURABAYA	INDONESIA	C	560/162	1990
240	CASTLETOWNSEND	IRELAND	I	175/051	1978
239	MALIN HEAD	IRELAND	C	175/011	1994
80	HADERA	ISRAEL	C	320/016	1995
210	PORT ROYAL, KINGSTON	JAMAICA	C	932/011	1969
82	ABURATSU	JAPAN	C	645/021	1994
103	CHICHIJIMA	JAPAN	C	648/001	1994
88	HAKODATE	JAPAN	C	641/031	1994
85	KUSHIMOTO	JAPAN	C	642/141	1994
89	KUSHIRO	JAPAN	C	641/022	1994
86	MERA	JAPAN	C	642/061	1994
104	MINAMI-TORI-SHIMA	JAPAN	C I		
83	NAGASAKI	JAPAN	C	645/064	1994
81	NAHA	JAPAN	C	646/024	1994
87	OFUNATO	JAPAN	C	642/022	1994
95	SYOWA	JAPAN	A	/041	1992
8	MOMBASA	KENYA		470/001	1995
145	CANTON IS. PHOENIX IS.	KIRIBATI	C	750/012	1995
146	CHRISTMAS IS. LINE IS.	KIRIBATI	C	770/022	1995
147	FANNING IS. LINE IS.	KIRIBATI	C I	770/013	1990 *
113	TARAWA, GILBERT IS.	KIRIBATI	C	730/008	1995
307	WONSAN	KOREA, P.D.R.	C	625/011	1992
84	PUSAN	KOREA, REPUBLIC OF		620/046	1992
271	FORT DAUPHIN (TAOLANARO)	MADAGASCAR			
15	NOSY-BE	MADAGASCAR		440/002	1994
293	CENDERING/KUALA TERENGGANU	MALAYSIA	C	550/017	1994
43	PENKALAN/TLDM/LUMUT	MALAYSIA	C	550/005	1994
27	GAN	MALDIVES		454/002	1995
28	MALE	MALDIVES		454/011	1995
110	ENIWETOK	MARSHALL IS.	I	720/002	1979 *
111	KWAJALEIN	MARSHALL IS.	C	720/011	1995
112	MAJURO	MARSHALL IS.	C	720/016	1995
252	NOUADHIBOU (CAP BLANC)	MAURITANIA	C I		
16	AGALEGA	MAURITIUS	C I		*
18	PORT LOUIS	MAURITIUS	C	450/012	1995
19	RODRIGUES	MAURITIUS	C	450/021	1995
267	ACAPULCO, GRO.	MEXICO	C	830/081	1994
161	CABO SAN LUCAS	MEXICO	C	830/020	1995
160	ISLA GUADALUPE	MEXICO	C	830/012	1985
163	MANZANILLO, COL.	MEXICO	C	830/072	1995
213	PROGRESO, YUC.	MEXICO	C	920/001	1990
164	PUERTO ANGEL	MEXICO	C	830/086	1986
162	SOCORRO IS.	MEXICO	C	830/061	1959
212	VERACRUZ, VER.	MEXICO	C	920/041	1994
282	TAN TAN	MOROCCO	C I		
10	INHAMBANE	MOZAMBIQUE			
11	PEMBA	MOZAMBIQUE		432/031	1993
37	AKYAB	MYANMAR		530/001	1942
141	MOULMEIN	MYANMAR	I	530/021	1964
314	WALVIS BAY	NAMIBIA		427/001	1994
114	NAURU, GILBERT IS.	NAURU	C	715/001	1994
127	AUCKLAND-WAITEMATA HBR.	NEW ZEALAND	C	690/001	1995

IOC Technical Series No. 50

Annex II - page 4

132	BALLENY IS.	NEW ZEALAND	I			*
129	BLUFF HBR.	NEW ZEALAND	C	690/041	1991	
128	CHATHAM IS.	NEW ZEALAND				
126	KERMADEC IS. (RAOUL)	NEW ZEALAND	I			*
134	SCOTT BASE	NEW ZEALAND	C I			
133	SCOTT IS.	NEW ZEALAND	I			*
101	WELLINGTON	NEW ZEALAND	C	690/011	1994	
259	LAGOS	NIGERIA	C	420/004	1995	
118	SAIPAN	NORTH MARIANA IS.	C	700/011	1995	
232	BJORNOYA (BEAR ISLAND)	NORWAY	I			
269	BOUVETEYA (BOUVET IS.)	NORWAY	I			*
275	HONNINGSVAG	NORWAY	C	040/015	1995	
230	JAN MAYEN IS.	NORWAY		012/001	1983	
235	MALOY	NORWAY	C	040/211	1995	
136	PETER IS.	NORWAY	I			*
234	RORVIK	NORWAY	C	040/136	1995	
5	MUSCAT (QABOOS PORT)	OMAN		487/021	1993	*
4	SALALAH	OMAN		487/001	1995	
295	GWADAR	PAKISTAN	C			
30	KARACHI, MANORO IS.	PAKISTAN	C	490/021	1987	
168	BALBOA	PANAMA		840/011	1995	
208	COCO SOLO	PANAMA		904/006	1995	
63	ALOTAU	PAPUA NEW GUINEA		670/006	1994	
272	DARU	PAPUA NEW GUINEA	I			
65	RABAUL	PAPUA NEW GUINEA	C	670/021	1995	
64	VANIMO	PAPUA NEW GUINEA	I			
173	CALLAO	PERU	C	848/032	1994	
71	DAVAO	PHILIPPINES	C	660/121	1993	
70	JOLO	PHILIPPINES	C	660/141	1993	
72	LEGASPI	PHILIPPINES	C	660/021	1993	
73	MANILA	PHILIPPINES	C	660/011	1993	
246	CASCAIS	PORTUGAL	C	210/021	1991	
244	FLORES, AZORES	PORTUGAL	C	360/041	1993	
250	FUNCHAL, MADEIRA	PORTUGAL	C	365/001	1993	
245	PONTA DELGADO, AZORES	PORTUGAL	C	360/002	1995	
206	SAN JUAN	PUERTO RICO/USA		938/021	1995	
231	BARENTSBURG (SPITSBERGEN)	RUSSIA	C	025/001	1995	
312	DIKSON	RUSSIA				
97	KALININGRAD	RUSSIA	C I	080/181	1986	
310	KRONSTADT-SHEPELEVO	RUSSIA				
91	LENINGRADSKAY (ANTARCTICA)	RUSSIA	I			*
25	MIRNY (ANTARCTICA)	RUSSIA	I			
294	MOLODEZHNYAYA (ANTARCTICA)	RUSSIA	I			*
274	MURMANSK	RUSSIA	C	030/018	1995	
92	NAGAEVO BAY	RUSSIA	C	630/011	1995	
311	NAKHODKA	RUSSIA				
270	NOVOLAZAREVSKAYA (ANTARCTIC)	RUSSIA	I			*
93	PETROPAVLOVSK-KAMCHATSKY	RUSSIA	C	630/021	1995	
98	PORT TUAPSE, BLACK SEA	RUSSIA	C	300/001	1995	
309	PROVIDENYA	RUSSIA		630/041	1989	
135	RUSSKAYA	RUSSIA	I			*
99	RUSSKAYA GAVAN	RUSSIA	C	030/001	1991	
313	TIKSI	RUSSIA				
90	YUZHNO KURILSK	RUSSIA	C I	630/001	1994	
260	SAO TOME	SAO TOME/PRINCIPE	I	423/001	1988	
253	DAKAR	SENEGAL		390/002	1995	
14	ALDABRA	SEYCHELLES	I	441/001	1977	*
273	PORT VICTORIA, HODOUL IS.	SEYCHELLES		442/007	1995	
256	ABERDEEN POINT	SIERRA LEONE	C I			
44	SINGAPORE	SINGAPORE		555/002	1993	
66	HONIARA	SOLOMON IS.	C	734/002	1995	
6	HAFUN (DANTE)	SOMALIA	I			
7	MOGADISHU	SOMALIA	I			
13	DURBAN	SOUTH AFRICA		430/091	1994	
20	MARION IS.	SOUTH AFRICA	I			
76	PORT ELIZABETH	SOUTH AFRICA		430/088	1994	
268	SIMONSTOWN	SOUTH AFRICA		430/061	1994	

249	CEUTA (SPANISH N. AFRICA)	SPAIN	C	340/008	1991
243	LA CORUNA	SPAIN	C	200/031	1991
251	LAS PALMAS, CANARY IS.	SPAIN	C	370/046	1994
33	COLOMBO	SRI LANKA		520/003	1992
233	GOTEBORG	SWEDEN	C	050/032	1995
9	MTWARA	TANZANIA	C I	460/001	1962
297	ZANZIBAR	TANZANIA	C	460/016	1995
39	KO LAK	THAILAND	C	600/021	1995
42	KO TAPHAO NOI	THAILAND	C	545/001	1995
125	TONGATAPU	TONGA		744/001	1994
203	PORT OF SPAIN	TRINIDAD AND TOBAGO	C	890/001	1990
121	FUNAFUTI, ELLICE IS.	TUVALU	C	732/011	1995
263	ASCENSION	U.K.	C	402/001	1996
221	BERMUDA, ST.GEORGES IS.	U.K.	C	950/011	1995
26	DIEGO-GARCIA IS.	U.K.		453/004	1995
266	EDINBURGH (TRISTAN DA CUNHA)	U.K.	C		
188	FARADAY (ANTARCTICA)	U.K.		A /003	1992
248	GIBRALTAR	U.K.		215/001	1995
236	LERWICK	U.K.	C	170/001	1995
241	NEWLYN	U.K.	C	170/161	1995
306	SIGNY, SOUTH ORKNEY ILS.	U.K.			
296	SOUTH CAICOS	U.K.			
187	SOUTH GEORGIA (S.ATLANTIC)	U.K.	I	866/001	1959 *
264	ST. HELENA	U.K.	C	425/001	1995
305	STANLEY, FALKLAND IS.	U.K.		863/002	1994
238	STORNOWAY	U.K.	C	170/251	1995
302	ADAK, ALEUTIAN IS.	U.S.A.	C	820/011	1995
149	APRA HARBOUR, GUAM, MARIANAS	U.S.A.	C	701/001	1995
219	DUCK, N.C.	U.S.A.	C	960/063	1995
289	FORT PULASKI, GA.	U.S.A.	C	960/031	1995
107	FRENCH FRIGATE SHOALS, H.IS.	U.S.A.	C	760/016	1995
217	GALVESTON	U.S.A.	C	940/007	1995
287	HILO, HAWAII, HAW.IS.	U.S.A.	C	760/061	1995
108	HONOLULU, HAWAIIAN IS.	U.S.A.	C	760/031	1995
109	JOHNSTON IS. HAWAIIAN IS.	U.S.A.	C	760/011	1995
216	KEY WEST	U.S.A.	C	940/071	1995
159	LA JOLLA, SAN DIEGO	U.S.A.	C	823/071	1995
303	MASSACRE BAY, ATTU IS., ALASKA	U.S.A.	I	820/001	1966
218	MIAMI (HAULOVER PIER)	U.S.A.	C I	960/002	1992
106	MIDWAY IS. HAWAIIAN IS.	U.S.A.	C	760/001	1995
290	NEWPORT, RI.	U.S.A.	C	960/161	1995
74	NOME	U.S.A.			
144	PAGO PAGO, AMERICAN SAMOA	U.S.A.	C	745/001	1995
183	PALMER (ANTARCTICA)	U.S.A.	I		*
288	PENSACOLA, FLORIDA	U.S.A.	C	940/041	1995
151	PRUDHOE BAY, ALASKA	U.S.A.	C		
158	SAN FRANCISCO	U.S.A.	C	823/031	1995
100	SAND POINT, ALASKA	U.S.A.	C	821/006	1995
150	SEWARD, ALASKA	U.S.A.	C	821/017	1995
154	SITKA, ALASKA	U.S.A.	C	821/031	1995
157	SOUTH BEACH, OREGON	U.S.A.	C	823/016	1995
102	UNALASKA, ALEUTIAN IS.	U.S.A.	C	820/021	1995
220	VENTNOR (ATLANTIC CITY), N.J.	U.S.A.	C	960/091	1995
105	WAKE IS. MARSHALL IS.	U.S.A.	C	720/021	1995
300	MONTEVIDEO	URUGUAY	C	870/011	1995
298	AVES IS.	VENEZUELA	C I		*
299	LA ORCHILA	VENEZUELA	C I		*
75	QUI NHON	VIET NAM	C	605/041	1994
3	ADEN	YEMEN, P.D.R.	I	485/001	1969
304	SOCOTRA IS.	YEMEN, P.D.R.	I		

ANNEX III

INTERNATIONAL STUDY GROUPS WITH SEA LEVEL COMPONENTS

INTERNATIONAL ASSOCIATION FOR THE PHYSICAL SCIENCES OF THE OCEAN

The IAPSO Commission on Mean Sea Level and Tides (CMSLT) is the main IAPSO body concerned with sea level measurements. It consists of approximately a dozen oceanographers and geodesists led by its President, who was Dr.D.Pugh during the period 1987-95, followed by Dr.C.Le Provost. Two major meetings were organised by the Commission on geodetic fixing of tide gauge benchmarks, the first at Woods Hole in 1988 [11] and the second in Surrey, UK in 1993 [12], both chaired by Dr.W.E.Carter, and since followed up by a third meeting [13]. In 1993, the CMSLT also co-hosted a workshop on vertical datums, chaired by Prof.E.Groten. It has urged IAPSO to support altimeter measurements of the ocean by means of IUGG resolutions.

Since 1995, the CMSLT has continued with the same policies, especially regarding implementation and use of new geodetic techniques to link tide gauges and altimetry, and will in future stimulate the use of a range of numerical modelling for understanding ocean variability and trends. GLOSS and CMSLT will continue to cooperate closely, for example in the development of data sets of tidal information.

INTERNATIONAL ASSOCIATION FOR GEODESY

At the IUGG General Assembly XXI, held in Boulder, Colorado, in July 1995, the International Association of Geodesy (IAG) established Special Commission 8 (SC8), Sea Level and Ice Sheet Variations, under Section V, Geodynamics. Dr.W.E.Carter was appointed President of SC8. The goals of SC8 are to:

- promote, encourage, and assist international cooperation in studies and observing programs to apply advanced geodetic techniques to understanding the current rates and causes of changes in sea level and ice sheets.
- foster interdisciplinary communication and cooperation among geodesists, geophysicists, glaciologists, oceanographers, and related earth scientists in the observation, study, interpretation, modelling and prediction of sea level and ice sheet temporal variations.
- maintain close liason with appropriate organizations such as Commissions and special Study Groups of the International Association for Physical Sciences of the Ocean (IAPSO), the International Geosphere-Biosphere Program (IGBP) Land Ocean Interaction in the Coastal Zone (LOICZ) Projects, and national agencies with related responsibilities and programs.

SC8 includes Sub-commissions and project teams to carry out the work of the Commission. Current Sub-commissions include:

- SSC8.1 Studies of the Baltic Sea (President, J. Kakkuri);
- SSC8.2 Vertical Crustal Deformation at the Edges of Continental Ice Masses (President R. Dietrich);
- SSC8.3 Geodetic Methods for Ice-sheet Monitoring (President Hans Werner Schenke).

ANNEX IV

LISTS OF STATIONS IN GLOSS-LTT, GLOSS-ALT and GLOSS-OC

GLOSS-LTT stations

Stations in the PSMSL RLR data set with at least 60 years of data, together with stations in the GLOSS core network with 40 or more years of MSL data. Columns show PSMSL station code, GLOSS code (if any), latitude and longitude, number of years of data in the PSMSL data set, and station name. The number of non-GLOSS long records in Scandinavia, US east coast etc. can be clearly seen (see text):

010001	229	64 09 N	21 56 W	41	REYKJAVIK
025001	231	78 04 N	14 15 E	48	BARENTSBURG
030018	274	68 58 N	33 03 E	44	MURMANSK
040151		63 26 N	09 07 E	60	HEIMSJO
040211	235	61 56 N	05 07 E	47	MALOY
040221		60 24 N	05 18 E	71	BERGEN
040261		58 58 N	05 44 E	64	STAVANGER
040321		59 54 N	10 45 E	74	OSLO
050001		58 57 N	11 11 E	62	STROMSTAD
050011		58 22 N	11 13 E	85	SMOGEN
050031		57 43 N	11 57 E	81	GOTEBORG - KLIPPAN
050041		57 06 N	12 13 E	95	VARBERG
050051		55 31 N	12 54 E	67	KLAGSHAMN
050071		55 25 N	13 49 E	100	YSTAD
050081		56 06 N	15 35 E	109	KUNGHOLMSFORT
050121		58 45 N	17 52 E	109	LANDSORT
050131		59 12 N	17 37 E	102	NEDRE SODERTALJE
050141		59 19 N	18 05 E	107	STOCKHOLM
050161		60 38 N	17 58 E	85	BJORN
050171		60 40 N	17 10 E	91	NEDRE GAVLE
050181		62 20 N	17 28 E	70	DRAGHALLAN
050191		64 00 N	20 55 E	104	RATAN
050201		64 55 N	21 14 E	80	FURUOGRUND
060001		65 40 N	24 31 E	68	KEMI
060011		65 02 N	25 25 E	99	OULU/ULEABORG
060021		64 35 N	24 25 E	65	RAAHE/BRAHESTAD
060041		63 42 N	22 42 E	74	PIETARSAARI/JAKOBSTAD
060051		63 06 N	21 34 E	105	VAASA/VASA
060061		63 04 N	20 48 E	61	RONNSKAR
060071		62 23 N	21 13 E	62	KASKINEN/KASKO
060101		61 36 N	21 28 E	78	MANTYLUOTO
060221		60 51 N	21 11 E	79	LYOKKI
060231		60 36 N	21 14 E	78	LYPYRTTI
060241		60 26 N	22 06 E	66	TURKU/ABO
060281		60 02 N	20 23 E	63	DEGERBY
060291		59 47 N	21 22 E	71	UTO
060311		59 57 N	22 22 E	77	JUNGFRUSUND
060316		59 46 N	22 57 E	70	RUSSARO
060331		59 49 N	22 59 E	99	HANKO/HANGO
060351		60 09 N	24 58 E	115	HELSINKI
060354		60 07 N	25 25 E	71	SODERSKAR
060361		60 34 N	27 11 E	60	HAMINA
080081		57 03 N	24 02 E	63	DAUGAVGRIVA
080151		56 32 N	20 59 E	63	LIEPAJA
080181	97	54 57 N	20 13 E	53	KALININGRAD
120012		54 11 N	12 05 E	138	WARNEMUNDE 2
120022		53 54 N	11 28 E	145	WISMAR 2
130001		54 34 N	11 56 E	96	GEDSER
130021		55 41 N	12 36 E	105	KOBENHAVN
130031		56 06 N	12 28 E	96	HORNBAEK
130041		55 20 N	11 08 E	97	KORSOR
130051		55 17 N	10 50 E	98	SLIPSHAVN
130071		55 34 N	09 46 E	105	FREDERICIA

IOC Technical Series No. 50

Annex IV - page 2

130081		56 09 N	10 13 E	106	AARHUS
130091		57 26 N	10 34 E	100	FREDERIKSHAVN
130101		57 36 N	09 58 E	101	HIRTSHALS
130121		55 28 N	08 26 E	105	ESBJERG
140011	284	53 52 N	08 43 E	69	CUXHAVEN
140012	284	53 52 N	8 43 E	144	CUXHAVEN 2
170011		57 09 N	02 05 W	61	ABERDEEN I
170012		57 09 N	02 05 W	104	ABERDEEN II
170053		55 00 N	01 27 W	98	NORTH SHIELDS
170101		51 27 N	00 45 E	97	SHEERNESS
170161	241	50 06 N	05 33 W	81	NEWLYN
190091	242	48 23 N	04 30 W	166	BREST
200030	243	43 22 N	08 24 W	45	LA CORUNA I
210021	246	38 41 N	09 25 W	104	CASCAIS
210031		37 06 N	08 40 W	78	LAGOS
230051	205	43 18 N	05 21 E	100	MARSEILLE
250011		44 24 N	08 54 E	89	GENOVA
270061		45 39 N	13 45 E	85	TRIESTE
300001	98	44 06 N	39 04 E	79	TUAPSE
360001	245	37 44 N	25 40 W	46	PONTA DELGADA
410001		04 53 N	01 45 W	64	TAKORADI
485001	3	12 47 N	44 59 E	66	ADEN
490021	30	24 48 N	66 58 E	48	KARACHI, MANORA ISLAND
500041		18 55 N	72 50 E	113	BOMBAY (APOLLO BANDAR)
500081	32	09 58 N	76 16 E	51	COCHIN (WILLINGDON IS.)
500091	34	13 06 N	80 18 E	44	MADRAS
500101	35	17 41 N	83 17 E	53	VISHAKHAPATNAM
545001	42	07 50 N	98 26 E	56	KO TAPHAO NOI
600021	39	11 48 N	99 49 E	62	KO LAK
609001		22 12 N	113 33 E	60	MACAU
610005	247	24 27 N	118 04 E	41	XIAMEN
630001	90	44 01 N	145 52 E	47	YUZHNO KURILSK
642061	86	34 55 N	139 50 E	62	MERA
642091		35 09 N	139 37 E	94	ABURATSUBO
642141	85	33 28 N	135 47 E	63	KUSHIMOTO
645011		32 26 N	131 40 E	95	HOSOJIMA
647021		34 54 N	132 04 E	91	TONOURA
647071		37 24 N	136 54 E	95	WAJIMA
660011	73	14 35 N	120 58 E	79	MANILA, S. HARBOR
660021	72	13 09 N	123 45 E	47	LEGASPI, ALBAY
660121	71	07 05 N	125 38 E	46	DAVAO, DAVAO GULF
660141	70	06 04 N	121 00 E	51	JOLO, SULU
680051	60	19 15 S	146 50 E	40	TOWNSVILLE I
680133		32 55 S	151 48 E	64	NEWCASTLE III
680141	57	33 51 S	151 14 E	97	SYDNEY, FORT DENISON
680142	57	33 51 S	151 14 E	76	FORT DENISON
680470	53	32 03 S	115 44 E	89	FREMANTLE II
680471	53	32 03 S	115 44 E	93	FREMANTLE
690002	127	36 51 S	174 46 E	86	AUCKLAND II
690012	101	41 17 S	174 47 E	46	WELLINGTON II
690022		44 24 S	171 16 E	68	LYTTELTON II
701001	149	13 26 N	144 39 E	48	GUAM
710001	116	07 27 N	151 51 E	47	CHUUK, MOEN ISLAND
720011	111	08 44 N	167 44 E	50	KWAJALEIN
720021	105	19 17 N	166 37 E	44	WAKE ISLAND
745001	144	14 17 S	170 41 W	46	PAGO PAGO
760001	106	28 13 N	177 22 W	48	MIDWAY ISLAND
760011	109	16 45 N	169 31 W	46	JOHNSTON ISLAND
760031	108	21 19 N	157 52 W	91	HONOLULU
760061	287	19 44 N	155 04 W	56	HILO, HAWAII ISLAND
820011	302	51 52 N	176 38 W	52	ADAK/SWEEPER COVE
821017	150	60 07 N	149 26 W	64	SEWARD
821031	154	57 03 N	135 20 W	58	SITKA
821051		55 20 N	131 38 W	77	KETCHIKAN
822001	155	54 19 N	130 20 W	70	PRINCE RUPERT
822071		49 17 N	123 07 W	68	VANCOUVER
822101		48 25 N	123 22 W	86	VICTORIA

822116	156	49 09 N	125 55 W	65	TOFINO
823001		48 22 N	124 37 W	62	NEAH BAY
823006		48 33 N	123 00 W	61	FRIDAY HARBOR (OCEAN. LABS.)
823011		47 36 N	122 20 W	97	SEATTLE
823013		46 13 N	123 46 W	71	ASTORIA (TONGUE POINT)
823021		41 45 N	124 12 W	61	CRESCENT CITY
823031	158	37 48 N	122 28 W	142	SAN FRANCISCO
823051		33 43 N	118 16 W	73	LOS ANGELES
823071	159	32 52 N	117 15 W	70	LA JOLLA (SCRIPPS PIER)
823081		32 43 N	117 10 W	90	SAN DIEGO (QUARANTINE STATION)
840011	168	08 58 N	79 34 W	88	BALBOA
842011	170	03 54 N	77 06 W	54	BUENAVENTURA
842021	171	01 50 N	78 44 W	43	TUMACO
845012	172	02 12 S	80 55 W	47	LA LIBERTAD II
850011	174	23 39 S	70 25 W	47	ANTOFAGASTA
850012	174	23 39 S	70 24 W	51	ANTOFAGASTA 2
850031	175	33 02 S	71 38 W	46	VALPARAISO
860011	190	47 45 S	65 55 W	43	PUERTO DESEADO
860031	191	42 46 S	65 02 W	41	PUERTO MADRYN
860081		38 35 S	58 42 W	64	QUEQUEN
860151		34 36 S	58 22 W	83	BUENOS AIRES
870011	300	34 54 S	56 15 W	48	MONTEVIDEO (PUNTA LOBOS)
902021	207	10 24 N	75 33 W	45	CARTAGENA
904011		09 21 N	79 55 W	72	CRISTOBAL
940008	217	29 19 N	94 48 W	88	GALVESTON II
940041	288	30 24 N	87 13 W	73	PENSACOLA
940071	216	24 33 N	81 48 W	83	KEY WEST
950011	221	32 22 N	64 42 W	58	ST. GEORGES/ESSO PIER
960011		30 24 N	81 26 W	68	MAYPORT
960021		30 41 N	81 28 W	86	FERNANDINA
960031	289	32 02 N	80 54 W	61	FORT PULASKI
960041		32 47 N	79 56 W	75	CHARLESTON I
960060		34 14 N	77 57 W	61	WILMINGTON
960071		36 57 N	76 20 W	69	HAMPTON ROADS
960076		38 52 N	77 01 W	65	WASHINGTON DC
960080		38 59 N	76 29 W	67	ANNAPOLIS (NAVAL ACADEMY)
960081		39 16 N	76 35 W	94	BALTIMORE
960087		39 57 N	75 08 W	95	PHILADELPHIA (PIER 9N)
960091	220	39 21 N	74 25 W	82	ATLANTIC CITY
960101		40 28 N	74 01 W	64	SANDY HOOK
960121		40 42 N	74 01 W	125	NEW YORK
960141		40 48 N	73 47 W	65	WILLETS POINT
960161	290	41 30 N	71 20 W	66	NEWPORT
960165		41 32 N	70 40 W	63	WOODS HOLE (OCEAN. INST.)
960171		42 21 N	71 03 W	75	BOSTON
960181		43 40 N	70 15 W	84	PORTLAND
960201		44 54 N	66 59 W	67	EASTPORT
970001		45 16 N	66 04 W	65	SAINTE JOHN, N.B.
970011	222	44 40 N	63 35 W	76	HALIFAX
970061		48 31 N	68 28 W	73	POINTE-AU-PERE
970071		46 50 N	71 10 W	67	QUEBEC (LAUZON)
970074		46 34 N	72 06 W	80	CAP A LA ROCHE
970078		46 20 N	72 33 W	89	TROIS-RIVIERES
970082		46 30 N	72 15 W	83	BATISCAN
970089		46 42 N	71 34 W	78	NEUVILLE

Additional stations added to GLOSS-LTT (see text):

420003	259	06 25 N	03 24 E	21	LAGOS
427001	314	22 57 S	14 30 E	29	WALVIS BAY
430061	269	34 11 S	18 26 E	36	SIMONS BAY
430088	76	33 58 S	25 38 E	19	PORT ELIZABETH
430091	13	29 53 S	31 00 E	25	DURBAN
440001	15	13 24 S	48 17 E	14	NOSY-BE
450011	18	20 09 S	57 30 E	19	PORT LOUIS
470001	8	04 04 S	39 39 E	16	MOMBASA

874051	194	25 01 S	47 56 W	33	CANANEIA
874092	195	22 54 S	43 10 W	28	ISLA FISCAL
A 003	188	65 15 S	64 16 W	35	ARGENTINE ISLANDS
A 041	95	69 00 S	39 34 E	16	SYOWA

GLOSS-ALT stations

Several tide gauge stations are presently being used in combination with laser and/or GPS and DORIS tracking to provide absolute calibrations of altimeters. None are GLOSS sites. At least two are required for this ongoing role:

Tide Gauge/Laser	Reference
Harvest, CA/US lasers	[Christensen, E.J., JGR, 99 (C12), 24465-24485, 1994]
Newhaven/Herstmonceux	[Murphy et al., JGR, 101 (C6), 14191-14200, 1996]
Australian site	[White et al., JGR, 99 (C12), 24505-24516, 1994]
Great Lakes	[Morris et al., JGR, 99 (C12), 24527-24539, 1994]

As regards the use of tide gauges for ongoing relative calibrations (Section 5.1.3), the following set designated GLOSS-ALT is derived from the report of Mitchum [43].

Five latitude ranges were chosen such that the surface area between 60S and 60N is divided equally, then 6 sites were chosen within each latitude range. More details can be found in [43] and in an upcoming NASA report by Mitchum. Of the 30 sites chosen, 17 already have a receiver at present within 100 km provided either by the IGS network (Figure 7.2) or by the US Continuously Operating Reference Station (CORS) network. Several others (e.g. Honolulu) should be easy to instrument, leaving approximately 10 stations that require special attention in the placement of GPS receivers.

SIG = An estimate of tide gauge quality, equal to standard deviation of the difference between altimeter and tide gauge if only 1 pass available, but also takes into account # of passes available.

N LAT, E LON, STATION = Position and "name" of tide gauge.

IGS/CORS = GPS receiver locations in both networks were examined - X means neither has one within 100 km of the tide gauge, a number is the distance in km of the closest GPS receiver.

SIG	N LAT	E LON	STATION	IGS	CORS	
---	- - - -	- - - -	-----	---	----	
85	-56.51	291.3	Diego Ramirez	X	X	Lat : 60S - 30S
67	-49.35	70.2	Kerguelen	2.7	X	
63	-43.95	183.4	Chatham Island	1.1	X	
102	-42.88	147.3	Hobart	12.3	X	
46	-33.62	281.2	Juan Fernandez	X	X	
78	-33.03	288.4	Valparaiso	90.8	X	
65	-27.15	250.6	Easter	6.5	X	Lat : 30S - 10S
39	-21.13	184.8	Nuku'alofa	X	X	
57	-20.16	57.5	Port Louis	X	X	
21	-15.97	354.3	St. Helena	X	X	
30	-17.52	210.4	Papeete	4.7	X	
42	-14.28	189.3	Pago Pago	X	X	
25	-7.90	345.6	Ascension	6.5	X	Lat : 10S - 10N
31	-7.29	72.4	Diego Garcia	3.5	X	
37	-4.67	55.5	Point La Rue	5.5	X	
40	-0.75	269.7	Santa Cruz	1.5	X	
45	1.99	202.5	Christmas	X	X	
29	8.73	167.7	Kwajalein	1.3	X	

52	13.43	144.6	Guam	29.3	X	Lat : 10N - 30N
50	16.75	190.5	Johnston Island	X	X	
35	21.31	202.1	Honolulu	X	X	
47	22.88	250.1	Cabo San Lucas	X	X	
59	24.55	278.2	Key West	X	X	
68	28.15	344.6	Las Palmas	48.2	X	
54	32.72	242.8	San Diego	18.1	8.4	Lat : 30N - 60N
58	32.37	295.3	Bermuda	0.1	X	
62	39.45	328.9	Flores ,Azores	X	X	
63	42.97	144.4	Kushiro	X	X	
107	48.37	235.4	Neah Bay	83.5	X	
95	57.73	207.5	Kodiak Island	X	22.8	

GLOSS-OC stations

This is a partial list of gauges based on criteria (i-iii) of GLOSS-OC in Section 5.1.3.

Gibraltar - Ceuta

Florida Current (Lake Worth, Settlement Point)

Gulf Stream (Bermuda - Duck, also return section Bermuda - Tenerife)

Kuroshio (Mera - Chichijima - Minamitorishima, also Tokara Strait islands of Naze, Nakanoshima and Nishinoomote used by Yamashiro and Kawabe, 1996) Several further Japanese and Korean stations could form a local network for monitoring circulation in the area [66].

NE Atlantic (Angmagssalik - Reykjavik - Torshavn - Lerwick)

NW Atlantic (Nain - Gothab)

Caribbean Straits (see Section 9.3.1 and Annex VIII)

ACC "Drake Passage/Scotia Sea choke points" (Diego Ramirez, Signy, Faraday, Esperanza, O'Higgins, Stanley - several sites on the south side of the Passage allows for data gaps)

ACC "African choke point" (Simons Bay - Marion - Syowa)

ACC "Indian Ocean choke points" (Amsterdam - Kerguelen - Heard - Crozet)

ACC "Australian choke point" (Hobart - Macquarie - Dumont d'Urville)

Antarctic sites (Faraday, Esperanza, Signy, Forster, Syowa, Mawson, Davis, Casey, Dumont d'Urville, Scott) As many sites as possible are need to allow for data gaps. O'Higgins can double for Esperanza, Rothera for Faraday, McMurdo for Scott etc.

"Indonesian through flow" (Davao and Darwin were used by Wyrтки, 1987. Padang, Benoa, Surabaya, Bitung are the only sites in Indonesia itself with recent data; they may not be optimal for through-flow studies.)

Pacific volume stations from Section 8.3.2 (Midway, Hilo, Johnston, Kwajalein, Christmas, Kanton, Pago Pago, Papeete)

Pacific equatorial gradients (Christmas, Baltra)

ANNEX V

LIST OF E-MAIL, FTP and WWW ADDRESSES

Tide Gauge Centres

Emails

psmsl@pol.ac.uk	PSMSL
bodcmail@pol.ac.uk	BODC 'delayed mode' WOCE Centre
caldwell@kapau.soest.hawaii.edu	UH Sea Level Center (for RQDS, IGOSS and 'fast' WOCE products)
motid@pacific.ntf.flinders.edu.au	NTF, Australia
ardmesqu@fox.cce.usp.br	Afro-America GLOSS News

FTP sites

bisag.nbi.ac.uk cd pub/psmsl	PSMSL
bisag.nbi.ac.uk cd pub/woce	BODC WOCE Sea Level Centre
kia.soest.hawaii.edu cd woce	UHSLC WOCE data
kia.soest.hawaii.edu cd rqds	UHSLC RQDS data
kia.soest.hawaii.edu cd islp	UHSLC ISLP-Pac data

WWW addresses

http://www.pol.ac.uk/sea_level.html	PSMSL
http://www.pol.ac.uk/psmsl/gb.html	GLOSS Bulletin
http://www.pol.ac.uk/bodc/bodcmain.html	BODC
http://www.pol.ac.uk/bodc/woce/dmsldac.html	BODC 'delayed mode' WOCE
http://www.soest.hawaii.edu/UHSLC/	Hawaii Sea Level Center
http://www.ntf.flinders.edu.au	NTF, Australia

Geodetic Data Centres

Emails

igsch@igsch.jpl.nasa.gov	IGS
iers@obspm.fr	IERS
willis@schubert.ign.fr	IGN, France (for DORIS)

WWW addresses

http://igsch.jpl.nasa.gov/	IGS
http://hpiers.obspm.fr	IERS
http://schubert.ign.fr:8000/CIAG/	IGN, France (for DORIS)

Altimetry Centres

Emails

blanc@atlas.cnes.fr	AVISO
bob@bigbird.grdl.noaa.gov	NOAA Lab. for Sat. Altimetry
services@nodc.noaa.gov	NODC/NOAA
podaac@jpl.nasa.gov	PODAAC, JPL
ray@nemo.gsfc.nasa.gov	GSFC Pathfinder Programme
helpdesk@ersus.esrinvas.esrin.esa.it	Earth Remote Sensing Services
plw@pol.ac.uk	POL Mapping Project
fpaf@ifremer.fr	CERSAT
chambers@utcsr.utexas.edu	Center for Space Research
remko.scharroo@lr.tudelft.nl	Delft University of Technology

WWW Addresses

http://topex-www.jpl.nasa.gov	Topex/Poseidon Home Page
http://www-aviso.cls.cnes.fr/	AVISO/TOPEX-POSEIDON Server
http://www-aviso.cls.cnes.fr/English/Products/Newsletters.html	AVISO Newsletter
http://ibis.grdl.noaa.gov/SAT/SAT.html	NOAA Lab. for Sat. Altimetry
http://www.nodc.noaa.gov	NODC/NOAA
http://podaac-www.jpl.nasa.gov	PODAAC, JPL
http://neptune.gsfc.nasa.gov/ocean.html	GSFC Pathfinder Programme
http://services.esrin.esa.it	Earth Remote Sensing Services
http://www.pol.ac.uk/gslc/dra.mapping.html	POL Mapping Project
http://www.ifremer.fr/cersat/	Information Page of CERSAT
http://www.csr.utexas.edu	Center for Space Research
http://dutlru8.lr.tudelft.nl	Delft University of Technology

Other Relevant WWW Addresses

http://www.unesco.org/ioc/	IOC
http://www.unesco.org/ioc/goos/iocgoos.htm	GOOS
http://www.gfy.ku.dk/~iag/	IAG
http://www.olympus.net/IAPSO/	IAPSO
http://www-gik.bau-verm.uni-karlsruhe.de/~fags/	FAGS
http://www.soc.soton.ac.uk/OTHERS/woceipo/ipo.html	WOCE
http://www.dkrz.de/clivar/hp.html	CLIVAR
http://www.geophys.washington.edu/tsunami/welcome.html	TSUNAMI INFORMATION

ANNEX VI

THE GLOSS STATION HANDBOOK CD-ROM - JULY 1996

In April 1996, the IOC invited the British Oceanographic Data Centre (BODC) to compile and publish a CD-ROM for GLOSS to mark the occasion of the "Second Conference of Parties of the UN Framework Convention on Climatic Change", Geneva, July 1996. It was intended initially that the CD-ROM should simply include the "GLOSS Station Handbook" (hence the title of the CD-ROM) containing detailed information on the tide gauge stations in the GLOSS network. In the event, it was decided to expand the contents to include a wide range of other material relevant to the measurement of mean sea level, including for example the complete data holdings of the PSMSL.

The CD-ROM contains six basic products:

- I Overview of the GLOSS System
- II The GLOSS Station Handbook
- III The PSMSL Data Sets
- IV IOC Manuals & Guides No. 14, Volume I
- V IOC Manuals & Guides No. 14, Volume II
- VI PSMSL Public Access Files

Products I, III, IV and V are hypertext documents in Adobe Acrobat format - they may be viewed on the user's screen or directed to the user's printer. The executable code for Acrobat Reader (which has its own on-line help) is included on the CD-ROM.

Product II is a BODC developed system with its own inbuilt software interface.

Products I to V were designed for use within a Windows environment.

Product VI is a set of simple flat ASCII files.

I: Overview of the GLOSS System

The Overview document provides an introduction to the GLOSS system, together with information on its current status and links to other international and regional sea level programmes. It contains information on training activities within GLOSS and includes a recently updated list of publications relevant to GLOSS and PSMSL. The document also gives a detailed description of the "GLOSS Station Handbook" and instructions on how to use the handbook.

II: The GLOSS Station Handbook

The Handbook is a comprehensive database of information about the tide gauge stations that make up the GLOSS network. A full description of each station is provided, including tide gauge details, benchmark information, data delivery systems, and the GLOSS national contact point. The accompanying software allows the selection and display of: a) station information, b) monthly and annual mean sea level plots for each station, if the data are held by PSMSL, and c) map images of the tide gauge sites and their benchmarks (available for about 100 stations).

III: The PSMSL Data Sets

The PSMSL Data Sets document contains a complete listing of the 42,360 station years of sea level data held by PSMSL as of June 1996 and covering 1754 stations worldwide. The monthly and annual mean values for each station are displayed in a computer printout format together with relevant supporting

documentation. A full catalogue of the data is provided with the stations arranged in geographic order - hypertext links from the catalogue allow the user to display data for the station(s) of interest.

IV and V: IOC Manuals & Guides No. 14

These two volumes comprise the IOC Manual on Sea Level Measurement and Interpretation. Volume I (Basic Principles) was published in 1985 and is based on training courses held at Bidston Observatory on behalf of PSMSL and IOC. It contains information on the scientific aspects of sea level change and on the practical aspects of sea level measurement and data reduction. Volume II (Emerging Technologies) was published in 1994 and is complementary to the earlier volume, extending and updating the material on measurements.

VI: PSMSL Public Access Files

The PSMSL maintains an on-line public access information system, accessible by anonymous FTP, containing not only full copies of its data holdings but also a wide range of other ancillary data and information. The system includes help/information files and Fortran programs, and is updated several times a year. The CD-ROM contains a full set of the information system files (as of June 1996), each stored in a simple flat ASCII format. User notes and information on the contents of these files may be found in the "readme" file that accompanies them. Contents include the following:

- a) a short description of PSMSL and its data sets;
- b) a catalogue printout of the PSMSL data holdings;
- c) copies of PSMSL's main data sets in a form suitable for further analysis, e.g. through the user's own Fortran programs;
- d) copies of PSMSL's main data sets in a computer printout format;
- e) a copy of the contents of the "GLOSS Station Handbook", excluding graphics images such as data plots and site maps;
- f) a bibliography of publications relevant to PSMSL and GLOSS;
- g) text and tables (but not figures) of the PSMSL "Ancillary Time Series" report of 1988. This includes a wide range of mean sea level data held by PSMSL which, for various reasons, have not been considered suitable, or to the standard necessary, for inclusion in PSMSL's main databases;
- h) a copy of the IAPSO Pelagic Tidal Constants data set;
- i) information on the availability of air pressure data;
- j) information on the POL/PSMSL TASK tidal analysis package.

Other Material included on the CD-ROM

It will be noted that some of the items contained in the PSMSL Public Access Files (e.g. items b), d), e) and f) above) duplicate information contained within the other products stored on the CD-ROM. This is because the other products have been designed primarily for use within a Windows environment. The duplicated information contained in the PSMSL Public Access Files has been included for the benefit of DOS and Unix users without access to Windows.

The CD-ROM also includes a DOS version of the "GLOSS Station Handbook" containing the same information as the Windows version but without the site location maps - these map images are accessible separately in a set of TIFF formatted files.

Finally, the CD-ROM also includes the executable code for Adobe Acrobat Reader for use in reading the hypertext documents which form the main body of the CD-ROM.

General Use

The CD-ROM contains a wide range of simple flat ASCII files that you can access directly whether through Windows, DOS or Unix. In particular, the PSMSL Public Access Files are stored in this form.

ANNEX VII

SUMMARY OF DATA SETS AND PRODUCTS (see also Chapters 8 and 9)

- PSMSL:** Monthly and annual means values of sea level from over 1750 stations.
IAPSO pelagic tidal constants data set.
GLOSS Bulletin newsletter on WWW.
WWW page pointers to all other sea level centres.
Compilation of GLOSS-related publications.
Keyword search facility for third world scientists.
Tidal analysis software.
- BODC/POL:** "Delayed mode" WOCE sea level data collection (approx. 125 sites).
GLOSS Handbook CD-ROM and floppy disk products.
ACCLAIM (Antarctic Circumpolar Current Levels by Altimetry and Island Measurements) sea level data set from Southern Ocean.
IOC/GLOSS Training courses organised.
- UHSLC:** "Fast" WOCE sea level data collection (over 100 sites).
Extensive data set from UH gauges in Pacific and Indian Oceans.
Research Quality Data Set (formerly TOGA data set) (over 300 sites).
IGOSS Sea Level Project in the Pacific (ISLP-Pac) including estimates of Pacific upper layer volume and equatorial current indices.
Major contributions to training courses.
Tidal analysis software.
- NTF:** Australian baseline array sea level data set.
Sea Level Project for the Southern Ocean (SLP-SO).
S.Pacific sea level and climate monitoring project data set.
Training and tidal analysis software.
- USP, Brazil:** Afro-America GLOSS News newsletter.
- IHO:** Tidal constants data set.
- U.Grenoble:** ROSAME (Réseau d'Observations Sub-Antarctiques du Niveau de la Mer) data set from the Southern Oceans.
- Mediterranean countries:**
Proposed pan-Mediterranean data collection in MedGLOSS.
Data sets from EU-funded SELF and SELF-II projects (chapter 9).
- European countries:**
Data sets collected from proposed EOSS/EuroGLOSS/EPTN projects (chapter 9).
- Caribbean countries:**
Data sets from IOCARIBE and proposed Hibiscus projects (chapter 9 and Annex VIII).
- Indian Ocean countries:**
Data sets from Indian Ocean CMAS activities (chapter 9).

Tsunami warning:

Operational Pacific and proposed Indian Ocean systems.

Storm surge prediction:

Operational systems in several countries, e.g. North Sea.

Altimeter centres:

Several sets of products derived from T/P and ERS data, almost all available via the WWW (Annex V).

ANNEX VIII

SUMMARY OF TIDE GAUGE/ METEOROLOGICAL STATIONS
IN THE INTRA-AMERICAS SEAS AS OF MAY 1996

GEF/OAS Stations are Planned. "GPS" indicates only those measurements made so far, not those planned.

Country:Site	Sponsor	Gauge Type	Trans- mission	GPS	Ancillary Sensors
Antigua & Barbuda: Parnham Codrington	GEF/OAS	Acoustic	GOES	No	Met., SST
	GEF/OAS	Acoustic	GOES	No	Met., SST
Aruba: Sint Nicolaas	IOC/UNEP	Pressure	None	No	None
Bahamas: Settlement Point Exuma	NOAA	Acoustic	GOES	Yes	Met., SST
	CMRC	Float	None	No	None
Barbados: Bridgetown Newcastle or Bathsheba	National	Float	None	No	None
	GEF/OAS	Acoustic	GOES	No	Met., SST
Belize: Glover Reef Belize City	GEF/OAS	Acoustic	GOES	No	Met., SST
	Finland	Acoustic	GOES	No	Met., SST
Bermuda: St. Georges	UK	Pressure	None	No	None
Cayman Islands: Grand Cayman	UK	Float	None	No	None
Colombia: Cartagena	NOAA	Float	None	No	None
Costa Rica: Puerto Limon	Finland	Pressure	GOES	Yes	Met., SST
Cuba: Cabo San Antonio Gibara Guntanamo Bay Siboney	National	Float	None	No	None
	National	Float	None	No	None
	IOC/UNEP	Acoustic	GOES	No	None
	National	Float	None	No	None
Dominica: Rosseau or Marigot	GEF/OAS	Acoustic	GOES	No	Met., SST
Dominican Republic: Puerto Plata Barahona	National	Bubbler	None	No	None
	National	Bubbler	None	No	None
France: Cayenne Kourou Le Robert Basse Terre	National	Float	None	No	None
	National	Pressure	None	No	None
	National	Float	None	No	None
	National	Float	None	No	None
Grenada: St. Georges or Pt. Salines	GEF/OAS	Acoustic	GOES	No	Met., SST
Guyana: Georgetown	IOC/UNEP	Acoustic	GOES	No	Met., SST
Honduras: Cochino Pequeno	Smithsonian	Acoustic	GOES	No	Met., SST
Jamaica: Port Royal Discovery Bay	IOC/UNEP	Acoustic	GOES	No	Met., SST
	GEF/OAS	Acoustic	GOES	No	Met., SST
Mexico: Progresso Puerto Morelos Tampico Veracruz	National	Float	None	No	None
	NOAA	Float	None	No	None
	National	Float	None	No	None
	National	Float	None	No	None
Netherlands Antilles: Curaco	National	Float	None	No	None
Panama: Coco Solo	Canal Zone	Pressure	None	No	None

IOC Technical Series No. 50

Annex VIII - page 2

St. Kitts-Nevis: Basseterre	GEF/OAS	Acoustic GOES	No	Met., SST
St. Lucia: Castries	GEF/OAS	Acoustic GOES	No	Met., SST
Trinidad & Tobago: Charlotteville	IOC/UNEP	Pressure GOES	No	None
Telephone Bay	GEF/OAS	Acoustic GOES	No	Met., SST
Turks & Caicos: South Caicos	IOC/UNEP	Acoustic GOES	No	Met., SST
USA: Fernandina Beach	National	Acoustic GOES	Yes	Met., SST
Sebastian Inlet	SITD	Acoustic GOES	Yes	Met., SST
Virginia Key	National	Acoustic GOES	Yes	Met., SST
Key West	National	Acoustic GOES	Yes	Met., SST
Naples	National	Acoustic GOES	Yes	Met., SST
Clearwater Beach	National	Acoustic GOES	Yes	Met., SST
Cedar Key	National	Acoustic GOES	Yes	Met., SST
Pensacola	National	Acoustic GOES	Yes	Met., SST
Grand Isle	National	Acoustic GOES	Yes	Met., SST
Galveston Pier 21	National	Acoustic GOES	Yes	Met., SST
Bob Hall Pier (Padre Island)	National	Acoustic GOES	Yes	Met., SST
San Juan PR	National	Acoustic GOES	Yes	Met., SST
La Parguera PR	National	Acoustic GOES	Yes	Met., SST
Lime Tree Bay USVI	National	Acoustic GOES	Yes	Met., SST
Charlotte Amalie USVI	National	Acoustic GOES	Yes	Met., SST
Venezuela: Cumana	National	Float	None	No None
La Guaira	National	Float	None	No None
Isla de Aves	National	?	?	? ?

ANNEX IX

LIST OF NATIONAL AND INTERNATIONAL CONTACTS

GLOSS NATIONAL CONTACTS

ANGOLA

Mrs. Maria de Fatima Jardim
Director, Centre des Recherches
Maritimes
Ministère des Pêches
Luanda
Angola

Mr. Kivuna Nkiamby
Instituto de Investigação Pesqueira
Caixa Postal 677
Lobito
Angola

ARGENTINA

Lic. Andres Jorge Lusquinos
Servicio de Hidrografía Naval
Avda. Montes de Oca 2124
1271 Buenos Aires
Argentina

Instituto Antártico Argentino
Dirección Nacional del Antártico
Cerrito 1248
1010 Buenos Aires
Argentina

Dr. Eduardo A. Rodriguez
Comisión Oceanográfica Intergubernamental
Representación Argentina
Cerrito 1248
1010 Buenos Aires
Argentina
Tel: (54 1) 812 16 89
Fax: (54 1) 812 20 39
E-mail: fiore.oceanar.mil.ar

AUSTRALIA

Mr. Bill Mitchell
Acting Director, National Tidal Facility
Flinders University of South Australia
GPO Box 2100
Adelaide
SA 5001
Australia
Tel: (618) 201 7524(direct)/7532
Fax: (618) 201 7523
E-mail: motid@pippin.cc.flinders.edu.au

BAHAMAS

Dr. George A. Maul
Florida Institute of Technology
150 West University Boulevard
Melbourne
Florida 32901-6988
U.S.A.
Tel: (1) (407) 768 8000
Fax: (1) (407) 984 8461
E-mail: gmaul@pelican.marine.fit.edu

Dr. George Dennis
Caribbean Marine Research Centre,
805E 46th Place,
Florida 32963,
U.S.A.

BANGLADESH

Mr. Abdul Matin Mondal
Tidal Research and Studies Section,
Dept. of Hydrography,
BIWT Authority, BIWTA,
141-143 Motijheel Commercial Area
Dhaka-2
Bangladesh
Tel: 253742/235042/236151-55 ext. 2107
Fax: 880-2-231072
Tlx: 642787 BIWTA BJ
Cbl: Authority

BARBADOS

Dr. Gillian Cambers
Coastal Conservation Project
The Garrison
St. Michael
Barbados

BRAZIL

Vice-Admiral Marcos Augusto Leal de Azevedo
Diretoria de Hidrografia e Navegação
Rua Barão de Jaceguay s/no. - Ponta da Armação
24048-900 - Niteroi, RJ
Brazil
Tel: (55 21) 717 04 23
Fax: (55 21) 620
E-mail: dhn01%hinave@mhs.mar.mil

Prof. Afranio Rubens de Mesquita
Instituto Oceanografico da
Universidade de São Paulo
Depto. de Oceanografica Fisica
Pca do Oceanografico 191
05508-900 São Paulo - SP
Brazil
Tel: (55 11) 210 43 11 ext. 6564
Fax: (55 11) 210 30 92
Email: ardmesqu@usp.br

CAMEROON

Délégation Générale de la Recherche
Scientifique et Technique
Comité National Permanent de
l'Homme et de la Biosphère
B.P. 1816
Yaoundé
Cameroon

CANADA

Dr. Savi Narayanan
Director, Marine Environmental Data Service
1202-200 Kent Street
Ottawa, Ontario K1A 0E6
Canada
Tel: 613 990 0265
Fax: 613 993 4568
E-mail: narayanan@ottmed.meds.dfo.ca

Mr. Fred Stephenson
Canadian Hydrographic Service
Institute of Ocean Sciences
P.O.Box 6000
Sidney, British Columbia
Canada V8L 4B2
Tel: 250 363 6349
Fax: 250 363 6323
E-mail: stephenson@ios.bc.ca

CAPE VERDE

Mr. Antonio de Cassia Sousa Barboa
Direcção Geral da Marinha e Portos
B.P. 7
San Vicente
Cape Verde

CHILE

Capitan Hugo Gorziglia
Presidente
Comite Oceanografico Nacional
Servicio Hidrografico y Oceanografico
de la Armada de Chile
Errazuriz 232, Playa Ancha
Casilla 324
Valparaiso
Chile
Tel: (56 32) 282 697
Fax: (56 32) 283 537
E-mail: cona@huelen.reuna.cl

PEOPLE'S REPUBLIC OF CHINA

Department of Marine Monitoring
and Forecast
State Oceanic Administration
1 Fuxingmenwai Avenue
Beijing 100860

Mr. Xu Chongjin
National Marine Environmental
Data and Information Service
WDC-D, 93 Liu Wei Road
Hedong District
Tianjin 300 171
People's Rep. of China
Tel: (86 22) 24 41 62
Tlx: 23138 NODC CN

COLOMBIA

Mrs. Gloria Leon
Jefe Division Meteorologia
IDEAM
Apartado Aereo No. 20032
Bogata D.E.
Colombia

Sr. Oscar Arango B.
Subdirector de Estudios
e Investigaciones
Instituto Colombiano de Hidrologia,
Meteorologica y Adecuacion de Tierras
Apartado Aereo 20032
Sante Fe de Bogota, D.E.
Colombia

CONGO

Mr. M.F. Guerdat
Directeur Centre ORSTOM
Centre de Recherches
Océanographiques
B.P. 1286
Pointe-Noire, Congo

COSTA RICA

Mr. Alejandro Gutierrez
Servicio Maregrafico y Estado del
Mar de Costa Rica (SERMAR-UNA)
Instituto Meteorologico Nacional
PO Box 7-3350
San Jose 1000
Costa Rica
Tel: (506) 23 8467 ext.109
Fax: (506) 23 1837
E-mail: gechever@ucrvn2.bitnet

COTE D'IVOIRE

Dr. Jacques Abe
Centre de Recherches
Océanographiques
ORSTOM
29, rue des Pêcheurs
B.P. V-18
Abidjan
Côte D'Ivoire

Département des Sciences de la
Terre
Université Nationale
B.P. 322
Abidjan, Côte D'Ivoire

CUBA

Instituto de Oceanologia
Ave. Ira. 18496
Rpto. Flores, Municipio Playa
Ciudad de la Habana, Cuba

DENMARK

Ms. Lonny Hansen
Det Danske Meteorologiske Institut
Lyngbyvej 100
DK-2100 Kobenhavn A
Denmark
Tel: +45 39 15 75 00
Fax: +45 39 15 73 01
E-mail: lha@dmi.min.dk

Mr. Palle Bo Nielsen
Royal Danish Administration of
Navigation and Hydrography
P.O. Box 1919
1023 Copenhagen - K
Denmark

DJIBOUTI

Dr. Nabil Mohamed
Institut Supérieur d'Etudes et de
Recherches Scientifiques et Techniques
BP 486, Djibouti
République de Djibouti
Tel: (253) 35 27 95
Fax: (253) 35 48 12

DOMINICAN REPUBLIC

Dr. Jose A. Ottenwalder
National Coordinator UNDP/GEF Project
Avenida Anacaona No. 9
Apartado 1414
Santo Domingo
Dominican Republic

ECUADOR

Sr. Director
Instituto Oceanografico de la
Armada
Departamento Ciencias del Mar
Casilla 5940, Guayaquil
Ecuador

EGYPT

The Director
Suez Canal Research Center
Suez Canal Authority
Ismailia
Egypt

The Director
Institute of Oceanography and Fisheries
Academy of Scientific Research
and Technology
101 Kasr El-Ainy Street
Cairo, Egypt
Tel: (20 2) 355 13 81
Fax: (20 2) 355 13 81
Tlx: 93069 ARST UN

FEDERATED STATES OF MICRONESIA

Mr. Heidi Primo
Climate Change Coordinator
FSM National Government P.O. PSP-4
Office of Planning and Statistics - Palikir
Pohnpei, FSM 96941
Federated States of Micronesia
Tel: (691) 320 2820
Fax: (691) 320 5832

FIJI

Chief Hydrographer
Fiji Hydrographic Service
Marine Department
PO Box 326
Suva, Fiji

Mr. Robin Yarrow
Permanent Secretary for Foreign Affairs
Ministry of Foreign Affairs
Government Buildings
Suva, Iles Fidji

FRANCE

Dr. C. Le Provost
Laboratoire d'Océanographie et de Géophysique
Spatiale
GRGS/Observatoire Midi Pyrenees
14, Avenue Edouard Belin
31400 Toulouse, France
Tel: (33) 5 61 33 29 23
Fax: (33) 5 61 25 32 05
E-mail: leprovost@pontos.cst.cnes.fr

Mr. B. Simon
Ingénieur sur Contrat
Section "géodesie-géophysique"
Centre "Hydrographie"
Hydrographique et Océanographique
de la Marine (EPSHOM)
B.P. 426
13 rue du Chatellier
29275 Brest Cedex
France
Tel: (33) 98 22 15 89
Fax: (33) 98 22 12 08
Tlx: HYDRO 940568

IGN, Service de Géodesie
Nivellement et Météorologie
2, avenue Pasteur
94160 Saint Mandé
France

Le Directeur
ORSTOM
213, rue La Fayette
75480 Paris Cedex 10
France
Fax: (33) (1) 43 98 80 53

Mr. C. Boucher
Institut Géographique National
136 bis, rue de Grenelle
75700 Paris Cedex 07 SP
France
Tel: (33) (1) 43 98 83 27
Fax: (33) (1) 43 98 80 53

Territoire des Terres Australes
et Antarctiques Françaises (TAAF)
34, rue des Renaudes
75017 Paris, France

Mr. Alain Soulan
Directeur
Service Météorologique Interrégional
Route du General Brosset
B.P. 645
97262 Fort de France Cedex
Martinique

GAMBIA

Mr. Nyada Yoba Baldeh
Executive Director
National Environment Agency
5, Fitzgerald Street
PMB, Banjul
Gambia
Fax: (220) 229 701

GERMANY

Prof. Dr. D Kohnke
BSH
Bernhard-Nocht-Strasse 78
P.O. Box 201220
D-W2000 Hamburg
Germany
Tel: (49) (40) 31 90 34 00
Fax: (49) (40) 31 90 50 00
Tlx: 215448 HYDRO D
E-mail: kohnke@m4.hamburg.bsh.d400.de

Dr. G. Gierman
AWI for Polar and Marine Research
Postfach 120161
Columbusstrasse
D-2850 Bremerhaven
Germany
Tel: (49) (471) 483 11 52
Fax: (49) (471) 483 11 02
Tlx: 238695 POLAR D

GHANA

Dr. I. Abu
Director
Survey Department
P.O. Box 191, Cantonments
Accra
Ghana

Mr. J. Wellwna-Mensah,
AESC Hydrology Division
PO Box 3969, Accra
Ghana

GREECE

Hellenic Navy Command
Hydrographic Service
Athens TGN 1040, Greece

GUATEMALA

Ing. Estuardo Velasquez V.
Director General
Instituto Nacional de Sismologia,
Vulcanologia, Meteorologia e Hidrologia
70 Avenida 14-57, Zona 13
Guatemala C.A.
Guatamala

GUINEA

Dr. S. Konate/Mr. Mamadouba Morlaye Camara
Directeur, Centre de Recherches
Scientifiques de Conakry-Rogbane
(CERESCOR)
B.P. 561, Rogbane, Conakry
Guinea
Tel: (224) 42 30 30
Fax: (224) 41 38 11
Tlx: 22331

GUYANA

Mr. S. M. Kahn
Chief Meteorological Officer
Hydrometeorological Service
Ministry of Agriculture
Homestretch Avenue
Durban Park, Guyana

HAITI

Mr. Emmanuel Brog
Secrétaire d'Etat des Finances et
des Affaires Economiques
Palais des Finances
Port-au-Prince
Haiti

Ing. Jean-Francois Rémy
Service Maritime et Navigation d'Haiti
B.P. 724
Port-au-Prince, Haiti

HONG KONG

The Director
Hong Kong Observatory
134A Nathan Road
Kowloon, Hong Kong

ICELAND

Mr. G. Bergsteinsson
Iceland Hydrographic Service
Rostholf 7094, 127
Reykjavik, Iceland

Icelandic Harbour Authority
Vesturvör 2, P.O. Box 120, IS-202
Kopavogur, Iceland

INDIA

Brig B.S. Rajal, Director
Geodetic and Research Branch
Survey of India
17 E.C. Road, Dehra Dun 248001 U.P.
India
Tel: (91) (135) 654 528
Fax: (91) (135) 629 944/627 623
Tlx: 585211 PGO IN

Shri J.V.R. Prasado Rao
Joint Secretary
Department of Ocean Development
Mahasagar Bhawan
Block 12, CGO Complex
Lodhi Road, New Dehli 110003
India
Tel: (11) 436 2101
Fax: (11) 436 0336/436 0779

Dr. S.R. Shetye
National Institute of Oceanography (NIO)
Dona Paula, Goa, India
Tel: (91) (832) 22 62 53 56 ext. 224/310
Fax: (91) (832) 22 33 40/22 13 60
E-mail: shetye@bcgoa.ernet.in
Tlx: 194-216 NIO IN/194-316 MGG IN

INDONESIA

Dr. R.W. Mantindas
Nat. Coord. Agency for Surveys
and Mapping (Bakosurtanal)
Jl. Raya Jakarta-Bogor, km 46
Cibinong
Bogor, Indonesia
Tel: (62) (21) 875 4592
Fax: (62) (21) 875 4592

Dr. K. Romimohtarto
Indonesian Hydro-Oceanographic
Service
Puslitbang Oseanologi - LIPI

Jalan Pasir Putih 1
Ancol Timur, Jakarta 11001
Indonesia

IRELAND

Cmdt. M.C. Walsh
Oifigina Suirbhreachta Ordanais
Paire au Fhionnuisce
Baile Atha Cliath
Dublin, Ireland
Tel: 01-213171 or 210121
Tlx: 30126
Tlg: Ordsur Dublin

Ocean Services Section
Forbairt
The Irish Science and Technology
Agency
Glasnevin, Dublin 9, Ireland
Tel: 01-370101
Fax: 01-379620
Tlx: 32501

ISRAEL

Mr. Dov S. Rosen
Nat. Inst. of Oceanography
Israel Oceanographic and Limnological Research
PO Box 8030, Tel Shikmona
Haifa 31080
Israel
Tel: (972) 485 15202
Fax: (972) 485 11911
E-mail: rosen@ocean.org.il

ITALY

Prof. S. Zerbini
Universita' Degli Studi di Bologna
Dipartimento di Fisica
Settore di Geofisica
Viale Berti Pichat, 8
I-401237 Bologna
Italy
Tel: (39 51) 630 50 19
Fax: (39 51) 25 01 06
E-mail: zerbini@astbol.bo.cnr.it

Istituto Idrografico della Marina
Passo Observatorio, 4
16134 Genova
Italy
Tel: (39) 265 451
Tlx: (39) 270 435 MARIDRI

JAMAICA

The Director
Survey Department
P.O. Box 493
Kingston
Jamaica

Mr. Calvin R. Gray
Director
National Meteorological Service
Norman Manley International Airport
Palisadoes, Jamaica

JAPAN

Dr. Tetsuro Suzuki
Director General of the Marine Department
Japan Meteorological Agency
3-4 Otemachi-1
Chiyoda-ku
Tokyo 100
Japan
Tel: (81 3) 3211 4966
Fax: (81 3) 3211 2032
Tlx: 222 2163 METTOK J
Cbl: METEOROAGENCY TOKY

Dr. M. Odamaki
Deputy Director
Coastal Surveys and Cartography Division
Hydrographic Department
Maritime Safety Agency
5-3-1 Tsukiji, Chuo-ku
Tokyo 104
Japan
Tel: (81 3) 3541 3815
Fax: (81 3) 3541 0723
E-mail: odamaki@wso9.cue.jhd.go.jp

KENYA

Mr. M.O. Odido
Kenya Marine and Fisheries
Research Institute
Mombasa Laboratory
P.O. Box 81651
Mombasa
Kenya
Tel: (254) (11) 47 11 29
Fax: (254) (11) 47 22 15
E-mail: kmfri@users.africaonline.co.ke

DEMOCRATIC REPUBLIC OF KOREA

Jong Dok Son
Korean National Oceanographic Data Centre
Hydrometeorological Service
PO Box 100, Pyongyang
DPR Korea

REPUBLIC OF KOREA

Office of Hydrographic Affairs
1-17, 7ga, Hangdong
Chung-gu, Inchon
Republic of Korea

MADAGASCAR

Dr. Jean Maharavo
Le Directeur
Centre National de Recherches
Océanographiques (CNRO)
B.P. 68, (207) Nosy-Be
Madagascar
Tel: 61373
Fax: 24075
Cbl: OCEAN NOSYBE

Mr. N.T. Razakafoniaina
Département d'Océanographie
Physique et Chimie (CNRO)
B.P. 68,(207) Nosy-Be, Madagascar

MALAYSIA

Mr. Abdul Majid Bin Mohamed
Director General
Department of Surveying and Mapping Malaysia,
Jalan Semarak
50578 Kuala Lumpur, Malaysia
Tel: (60 3) 2925311/2955932
Fax: (60 3) 2917457
Tlx: 28148 SURMAP MA

Mr. Ahmad Fauzi Bin Nordin
Director of Mapping
Department of Surveying and Mapping
Jalan Semarak
50578 Kuala Lumpur, Malaysia
Tel: (60 3) 2925311/2926750
Fax: (60 3) 2934084
Tlx: 28148 SURMAP MA

Hydrographic Directorate
Department of Navy, Ministry of Defence
Jalan Padnag Tembak
50634 Kuala Lumpur
Malaysia

MALDIVES

Mr. Abdullah Naseer
Reef Scientist
Marine Research Station
Ministry of Fisheries and Agriculture
Male
Republic of Maldives

MAURITANIA

Dr. Sidi El Moctar Ahmed Taleb
Directeur, Centre National de la
Recherche Océanographique des
Pêches (C.N.R.O.P.)
B.P. 22, Nouadhibou
Mauritania
Tel: (222) 45124/49035
Fax: (222) 49050/49030
Tlx: 415 MTN

MAURITIUS

Mr. S. Ragoonaden/Mr. K. Dunpath
Meteorological Services
Headquarters
Vacoas
Mauritius
Tel: (230) 6861031/32
Fax: (230) 6861033
Tlx: 4722 METEO IW
E-mail: meteo@intnet.mu

MEXICO

Contralmirante S.I.O. Alberto M.
Vazquez de la Cerda
Director General de Oceanografico Naval
Secretaria de Marina
Direccion General de Oceanografia Naval
Edificio "B" Primer Nivel Eje 2 Oriknik No881
(Tramo H. Escuela Naval Militar)
Col. los Cipresses
Delag. Coyoacan
04830 Mexico DF
Tel: (52) 679 6411/684 8188 ext. 1202/1203
Fax: (52) 679 6411 (ext. 1205)

Dr. Julio Sheinbaum
CICESE
Apartado Postal 2732
Ensenada, B.C. 22800
Mexico

MOROCCO

Dr. Orbi Abdellatif
Le Directeur
Institut Scientifique des Pêches
Maritimes
2, rue Tiznit
B.P. 21
Casablanca
Morocco
Tel: (212) 26 81 92/27 60 88
Fax: (212) 26 69 67
Tlx: IPEMAR 223 823 M

MOZAMBIQUE

Director
Instituto de Investagacao
Pesqueira
P.O. Box 4603
Maputo
Mozambique
Tel: 258-1-490307
Fax: 258-1-492112
E-mail: mazibe@magumba.uem.mz

Mr. D. Chemane
INAHINA
P.O. Box 2089
Av. Karl-Marx 153
Maputo, Mozambique
Tel: 258-1-430186
Fax: 258-1-430185
E-mail: director@inahina.uem.mz

UNION OF MYANMAR (Burma)

Mr. Maung Maung Hla
Chief Engineer
Myanmar Port Authority
No. 10 Panasodan Street
Yangon
Union of Myanmar
Fax: 95 1 65944
Tlx: 21512 BURMET

Mr. U. Ohn Gyaw
Deputy Director Hydrology
Dept. of Meteorology and Hydrology
Mayangon
11061 Yangon
Union of Myanmar

NAMIBIA

Mr. B.W. Oelofson
Deputy Director for Fisheries for Namibia
Ministry of Agriculture, Fisheries, Water
and Rural Developemnt
Private Bag 13193
Windhoek 9000
Namibia

NEW ZEALAND

Mr. B.Ward
The Tidal Officer
Royal New Zealand Navy
Hydrographic Office
P.O. Box 33-341
Takapuna, New Zealand
Tel: (64 9) 489 5859
Fax: (64 9) 489 5063

Dr. J. Hannah
Professor and Head of Department
Department of Surveying
P.O. Box 56
University of Otago
Dunedin
New Zealand

NIGERIA

Mr. Larry Awosika
Nigerian Institute for Oceanography
and Marine Research (NIOMR)
Federal Ministry of Agriculture
and Natural Resources Development
Victoria Island
P.M.B. 12729
Lagos
Nigeria
Tel: (234 1) 61 95 17
Fax: (234 1) 61 95 17
E-mail: niomr.nig@lagosmail.sprint.com
Tlx: OCEANGRAF

NORWAY

Norwegian Hydrographic Service
P.O.Box 60
4001 Stavanger
(Visit address: Lervigsveien 36
4014 Stavanger)
Norway
Tel: (47) 51 85 87 00
Fax: (47) 51 85 87 01
E-mail: slotsvin@sjo.statkart.no

OMAN

Mr. S.H.G. Bennett
Hydrographer
Royal Navy of Oman
Ministry of Defence Headquarters
P.O. Box 723
CPO SEEB, Postal Code 111
Muscat
Sultanate of Oman
Tel: (968) 618198

PAKISTAN

Mr. Syed S.H. Niz Rizvi
Director General
National Institute of Oceanography
37-K, Block 6, P.E.C.H.S.
Karachi 29
Pakistan
Tel: (92 21) 43 43 08
Fax: (92 21) 586 0129
Tlx: 24681 NIO PK
Tlg: OCEANOLOGY KARACHI

PANAMA

Dr. Epiñenides Díaz
Research Biologist
Departamento de Evaluación Pesquera
Dirección General de Recursos
Marinos
Apartado 3318
Panama 4

Mr. Joseph A. Brady
Hydrologist
Engineering Division,
Meteorology and Hydro. Branch,
Panama Canal Commission,
APO AA 34011-2300
U.S.A.

Dra. Maria Concepcion Donoso
Centro de Investigaciones Hidraulicas
Universidad de Tecnologia
Estafeta Parque Lefevre
Panama 10

PAPUA NEW GUINEA

Mr. P. Chakumai
PNG Hydrographer
Marine Division
Department of Transport and Civil Aviation
P.O. Box 457
Konedobu
Papua New Guinea

Mr. K. Ridgeway
Division of Oceanography
CSIRO, GPO Box 1538
Salamanca Parade
Hobart
Tasmania 7001
Australia

PERU

Rear Admiral Jorge Brousset Barrios
Director
Direccion de Hidrografia y
Navegacion de la Marina
Camarra 500 Chucuito
Casilla Postal 80
Callao, Peru

PHILIPPINES

Conrado M. Santos
Bureau of Coast and Geodetic
Survey
P.O. Box 1620
Manila, Philippines

Director
Coast and Geodetic Survey Dept.
421 Baracca St., San Nicolas
Manila, Philippines

PORTUGAL

Vice-Admiral Antonio Cavaleiro de Ferreira
Director General
Instituto Hidrográfico
Rua das Trinas 49
P-1296 Lisboa Codex
Portugal

Lt. Cdr. Carlos M.Lemos
Tides Division
Instituto Hidrográfico
Rua das Trinas 49,P-1296
Lisboa Codex
Portugal

RUSSIAN FEDERATION

Dr. Oleg Zilbershtein
Head of Dept. for Sea Dynamics of the
State Oceanographic Institute
Russian Federal Service for Hydrometeorology
and Environmental Monitoring
(ROSHYDROMET)
Kropotkinsky St. 6
Moscow 119034, Russia
Tel: (7 095) 246 81 20
Fax: (7 095) 246 39 70
E-mail: oleg@soins.msk.ru
Tlx: 411117 RUMS SU/411968 OKEAN SU

Dr. N.O. Smirnov
Deputy Director, All Russian Research
Institute of Hydrometeorological
Information - World Data Centre-B
6 Korolev Street
Obninsk, Kaluzhskaya obl.
249020 Russia
Tel: (7 095) 255 21 94
Fax: (7 095) 255 22 95

Dr. I.E. Danilov
Deputy Director, Arctic and Antarctic Research
Institute
State Scientific Centre of the Russian Federation
Rosgidromet, 38, Behring Street
St. Petersburg, 199397 Russia
Tel: (7 812) 352 27 91/352 15 20
Fax: (7 812) 352 26 88
E-mail: aaricoop@sovam.com

EL SALVADOR

Reynaldo Di Majo
Jefe Depto. Hidrografia
IGN Pablo Arnoldo Guzman
Av. Juan Bertis 79,Ciudad Delgado
Apartado Postal No. 247
San Salvador
El Salvador C.A.

AMERICAN SAMOA

Ministry of Transport
Marine and Shipping Division
P.O. Box 1607
Apia
American Samoa

SÃO TOMÉ & PRÍNCIPE

Mr. Manuel de Conceirao
Neto d'Alva Texeira
Director,
Marine Biology Laboratory
Direcção das Pescas
Caixa Postal Box 59
São Tomé
São Tomé & Príncipe
Tel: (239 1) 22 24 14
Fax: (239 1) 22 20 91

Ana Chaves
Secretaria de Estado das Pescas
São Tomé and Príncipe

SENEGAL

Mr. Diafara Toure
Coordinateur du Programme
Environnement
Centre de Recherches
Océanographiques de Dakar
Thiaroye (CRODT)
B.P. 2241
Dakar
Senegal
Tel: (221) 340534/340536

SEYCHELLES

Ministry of National Development
Dept. of Lands, Planning and Survey
P.O. Box 199
Independence House
Port Victoria
Seychelles

Mr. Marc Desnousse
Principal Technical Officer
Meteorological Office
Directorate of Civil Aviation
Ministry of Tourism and Transport
P.O. Box 181, Victoria, Mahe
Seychelles
Tel: (248) 373 001 ext. 114
Fax: (248) 373 222

SIERRA LEONE

Dr. R. Johnson
Institute of Marine Biology and
Oceanography
Furah Bay College
University of Sierra Leone
Freetown
Sierra Leone

SINGAPORE

Mr. Wilson Chua
Hydrographer
Port of Singapore Authority
7 Kerppel Road 02-28
Tanjong Pagar Complex
Singapore 0208

SOLOMON ISLANDS

Mr. F. Bugotu
Permanent Secretary
Ministry of Foreign Affairs and
International Trade
P.O. Box G.10, Honaria
Solomon Islands

SOMALIA

Ministry of Fisheries
P.O. Box 438
Mogadishu
Somalia

Mr. Ahmed Hagi Ali Adani
The General Manager
Somali Ports Authority
P.O. Box 935
Mogadishu
Somalia

SOUTH AFRICA

Capt. M. Thomson
Superintendent Tidal Information
Hydrographic Office
Private Bag X1
Tokai 7966
South Africa

Prof. Geoff Brundrit
Department of Oceanography
University of Cape Town, Rondebosch 7700
South Africa
Tel: (27 21) 650 3277
Fax: (27 21) 650 3979
E-mail: shirley@physci.act.ac.za
elley@physci.act.ac.za

SPAIN

Mrs. Maria Jesus Garcia
Instituto Espanol de Oceanografia (IEO)
Corazon de Maria, 8, 28020 Madrid
Spain
Tel: (34) (1) 347 36 12
Fax: (34) (1) 413 55 97
E-mail: mjesus.garcia@md.oco.es

SRI LANKA

Mr. S.R. Amarasinghe
Director, Coastal Conservation
Coast Conservation Dept.
Maligawatta Secretariat
Colombo 10
Sri Lanka

Dr. H.V. Dayananda
Chief Engineer (Research)
Tilak Ekanayake
Sri Lanka Ports Authority
Colombo 1
Sri Lanka

Dr. M.U. Jayasekara
Director General
National Aquatic Resources Agency (NARA)
Mattakkuliya
Colombo 15
Sri Lanka
Tel/Fax: (94 1) 522932

SWEDEN

Mr. Barry Broman
Senior Oceanographer
Swedish Meteorological and
Hydrological Institute
Folkborgsvagen 1
S-60176 Norrkoping
Sweden
Tel: (46 11) 158000
Fax: (46 11) 170207/170208
Tlx: 64400 SMHI S

TANZANIA

Haji Adam Haji
Director, Department of Lands and
Surveys
P.O. Box 811
Zanzibar
Tanzania

Institute of Marine Sciences
University of Dar-es-Salaam
P.O. Box 668
Zanzibar
Tanzania
Tel: (255 54) 32128/30741
Fax: (255 54) 33050/32128/32159
E-mail: ims@zims.udsm.ac.tz

THAILAND

The Director
Hydrographic Department
Royal Thai Navy
Bangkok 10600, Thailand

TRINIDAD & TOBAGO

Mr. Francis L. Charles
Head, Trinidad and Tobago
Hydrographic Unit
P.O. Box 1104
Port of Spain, Trinidad and Tobago

TURKEY

Harita Genel Komutanligi
Jeodezi Dairesi Baskanligi
Cebeci, 06100 Ankara, Turkey

UNITED KINGDOM OF GREAT BRITAIN & NORTHERN IRELAND

Jon Shanklin
British Antarctic Survey
Ice and Climate Division
High Cross
Madingley Road
Cambridge, CB3 0ET, U.K.

Captain G. Hope
Hydrographic Office
Ministry of Defence
Taunton, TA1 2DN
Somerset, U.K.

Dr. Lesley Rickards
British Oceanographic Data Centre
Proudman Oceanographic Laboratory
Bidston Observatory
Birkenhead, Merseyside, L43 7RA, U.K.
Tel: (44) (151) 653 8633
Fax: (44) (151) 653 6269
Tlx: 62891 OCEANB G
E-mail: ljr@pol.ac.uk

UNITED STATES OF AMERICA

Wolfgang Scherer
Senior Staff Oceanographer
Office of Ocean and Earth Sciences N/OES
National Ocean Service
National Oceanic and Atmospheric
Administration
1035 East-West Highway, Station 6167
Silver Spring
Maryland 20910
U.S.A.
Tel: (1) (301) 713 2891
Fax: (1) (301) 713 4392
E-mail: wscherer@nos.noaa.gov

Dr. M. Merrifield
University of Hawaii at Manoa
Department of Oceanography
1000 Pope Road MSB 307
Honolulu, Hawaii 96822
U.S.A.
Tel: (1) 808 956 61 61
Fax: (1) 808 956 23 52
E-mail: markm@soest.hawaii.edu

URUGUAY

Servicio de Oceanografía, Hidrografía,
Meteorología de la Armada
Capurro 980, Casilla de correos 1381
Montevideo
Uruguay
Fax: (598 2) 399 220
Tlx: UY 22257

VENEZUELA

Mr. Ruben Aparicio Castro
Instituto Oceanográfico de
Venezuela
Universidad de Oriente
Apartado de Correos 245
Cumana, Venezuela
Tlx: 93152 UDONS VE

The Director
National Geographic Commission (CONICIT)
Aportado Postal 70 617
Los Ruices, 1070-A Caracas
Venezuela

WEST INDIES

Mr. Chris Nimes
Fisheries Advisory Officer
Ministry of Natural Resources
Grand Turk
Turks and Caicos Islands
West Indies

VIET NAM

Prof. Dang Ngoc Thanh
National Committee for IOC of Viet Nam
Vien Khoa Hoc Viet Nam
Nghia Do - Tu Liem
Hanoi
Viet Nam

Dr. Nguyen Ngoc Thuy
The Director
Marine Hydrometeorological Centre
Hydrometeorological Service of the
Socialist Republic of Viet Nam
No. 4 Dang Thai Than St.
Hanoi, Viet Nam

PEOPLE'S DEMOCRATIC REPUBLIC OF YEMEN

Mr. A. Hammadi
Director, Marine Science and
Resources Research Centre
Ministry of Fish Wealth
P.O. Box 1242
Aden, P.D.R. of Yemen

Mr. Gamal Bawazir
P.O. Box 414
Crater, Aden

GLOSS INTERNATIONAL CONTACTS

Permanent Service for Mean Sea Level (PSMSL)

Dr. Philip Woodworth
Director, PSMSL
Proudman Oceanographic Laboratory
Bidston Observatory, Birkenhead
Merseyside L43 7RA, U.K.
Tel: (44) (151) 653 8633
Fax: (44) (151) 653 6269
E-mail: plw@pol.ac.uk

**University of Hawaii Sea Level Center
(UHSLC)**

Dr. Mark Merrifield, Director
UH Sea Level Centre
University of Hawaii
1000 Pope Road, MSB 307
Honolulu Hawaii 96822-2336
U.S.A.
Tel: (1) 808 956 61 61
Fax: (1) 808 956 23 52
E-mail: markm@soest.hawaii.edu

**World Ocean Circulation Experiment
(WOCE)**

**WOCE Sea Level Data Assembly Centre - Fast
Delivery Centre (WOCE-DAC)**

Dr. Mark Merrifield, address as above

**WOCE Sea Level Data Assembly Centre -
Delayed Mode Centre (WOCE-DAC)**

Dr. Lesley Rickards
British Oceanographic Data Centre
Proudman Oceanographic Laboratory
Bidston Observatory
Birkenhead, Merseyside L43 7RA, U.K.
Tel: (44) (151) 653 8633
Fax: (44) (151) 652 3950
E-mail: ljr@pol.ac.uk

**IGOSS Sea Level Programme in the Pacific
(ISLP-Pac)**

**Specialized Oceanographic Centre (SOC) for
Mean Sea Level in the Pacific**

Dr. Mark Merrifield, address as above

**Sea Level Project for the Southern Ocean
(SLP-SO)**

National Tidal Facility
The Flinders University of South Australia
GPO Box 2100, Adelaide, South Australia 5001
Australia
Tel: (08) 201 7532
Fax: (08) 201 7523
E-mail: motid@pacific.ntf.flinders.edu.au

**Pilot Monitoring Activity on Sea Level
Changes and Associated Coastal Impacts in
the Indian Ocean (SLP-IO)**

Dr. Satish Shetye
Physical Oceanography Division
National Institute of Oceanography (NIO)
Dona Paula, Goa 403-004, India
Tel: (91) (832) 22 62 53 56 ext. 224/310
Fax: (91) (832) 22 33 40/22 13 60
E-mail: shetye@bcgoa.crnet.in
Tlx: 194-216 NIO IN/194-316 MGG IN

**Monitoring system for sea level measurements
in the Mediterranean (MedGLOSS proposal)
(CIESM)**

Dr. Dov Rosen
Israel Oceanographic and Limnological Research
Ltd.(IOLR)
Tel Shikmona-P.O.Box 8030
Haifa, Israel
Tel: (972) 485 15202
Fax: (972) 485 11911
E-mail: rosen@ocean.org.il

Prof. Frédéric Briand
Commission Internationale Pour L'Exploration
Scientifique de la Mer Méditerranée (CIESM)
16, Bd. de Suisse
MC 98000-Monaco
Tel: (33) 93 30 38 79
Fax: (33) 92 16 11 95
E-mail: ciesm@unice.fr

**South Pacific Sea Level and Climate
Monitoring Project**

National Tidal Facility, Australia
address as above

**Height Investigations to Broaden Information
both on mean Sea Level Changes and
Understanding of Surface vertical movements
in the Caribbean and adjacent regions
(HIBISCUS Project)**

Prof. Susanna Zerbini
Dipartimento di Fisica
Settore di Geofisica
Università Degli Studi di Bologna
Viale C.Berti Pichat, 8
40127 Bologna, Italy
Tel: (39 51) 630 50 19
Fax: (39 51) 25 01 06
Tlx: 520634 INFNBO I
E-mail: zerbini@astbol.bo.cnr.it

**Sub-Commission for the Caribbean and
Adjacent Regions (IOCARIBE). GLOSS
Regional Coordinator for IOCARIBE:**

Prof. George Maul
Director, Division of Marine
and Environmental Systems
Florida Institute of Technology
150 West University Boulevard
Melbourne, Florida 32901-6988
U.S.A.
Tel: (1) (407) 768 8000
Fax: (1) (407) 984 8461
E-mail: gmaul@pelican.marine.fit.edu

**IOC Regional Committee for the Central
Eastern Atlantic (IOCEA). GLOSS Regional
Coordinator for IOCEA:**

Dr. Larry Awosika
Nigerian Institute for Oceanography & Marine
Research (NIOMR)
Federal Ministry of Agriculture & Natural
Resources Development
P.M.B. 12729 Victoria Island
Lagos
Nigeria
Tel: (234 1) 61 95 17
Fax: (234 1) 61 95 17
E-mail: niomr.nig@lagosmail.sprint.com
Tlx: OCEANGRAF

**IOC Regional Committee for the Cooperative
Investigation in the North and Central
Western Indian Ocean (IOCINCWIO).
GLOSS Regional Coordinator for
IOCINCWIO:**

Mr. M.O. Odido
Kenya Marine and Fisheries
Research Institute
Mombasa Laboratory
P.O. Box 81651
Mombasa
Kenya
Tel: (254) (11) 47 11 29
Fax: (254) (11) 47 22 15
E-mail: kmfri@users.africaonline.co.ke

**Sea Level Fluctuations: Geophysical
Interpretation and Environmental Impact
Project - SELF Project (The Mediterranean
and Black Seas)**

Prof. Susanna Zerbini, address as above

**Intergovernmental Oceanographic
Commission (IOC): Group of Experts on
Global Sea Level Observing System (GLOSS).**

Chairman:
Dr. Philip Woodworth, address as above

GLOSS Technical Secretary:
Ms. Janice Trotte (acting)
Intergovernmental Oceanographic
Commission (IOC)
UNESCO, 1 rue Miollis
75732 Paris Cedex 15, France
Tel: (33) (1) 45 68 39 78
Fax: (33) (1) 40 56 93 16
E-mail: jtrotte@unesco.org

**International Hydrographic Organisation
(IHO)**

Mr. Hans-Peter Rohde
Professional Assistant (Hydrography)
International Hydrographic Bureau
7, Avenue President J.F. Kennedy
MC-98011 Monaco Cedex
Principality of Monaco
Tel: (33) 93 50 65 87
Fax: (33) 93 25 20 03
E-mail: ihb@unice.fr

Tidal Constituent Bank

Tidal Constituent Bank
Canadian Hydrographic Service
615 Booth Street
Ottawa, Ontario, Canada K1A 0E6
Tel: (1) 613 995 44 13
Fax: (1) 613 996 90 53

**International Association for the Physical
Sciences of the Ocean (IAPSO) Commission on
Mean Sea Level and Tides.**

President:
Dr. C. Le Provost
Laboratoire d'Océanographie et de
Géophysique Spatiale
GRGS/Observatoire Midi Pyrénées
14, Avenue Edouard Belin
31400 Toulouse, France
Tel: (33) 5 61 33 29 23
Fax: (33) 5 61 25 32 05
E-mail: leprovos@pontos.cst.cnes.fr

**Commission Internationale pour l'Exploration
Scientifique de la Mer Méditerranée (CIESM)**

Prof. Frédéric Briand
Directeur Général
16, Bd de Suisse
MC 98000
Monaco
Tel: (33) 93 30 38 79
Fax: (33) 92 16 11 95
E-mail: ciesm@unice.fr

**Scientific Committee on Ocean Research
(SCOR of ICSU) Working Group on Sea Level
and Erosion of the World's Coastline**

Chairman:
Prof. P.D.Komar
College of Oceanography
Oregon State University
Oceanography Administration
Building 104
Corvallis, OR 97331-5503
U.S.A.

**International GPS Service for Geodynamics
(IGS)**

IGS Central Bureau
Director: Mrs. Ruth E. Neilan
Jet Propulsion Laboratory
4800 Oak Grove Drive
Pasadena, CA 91109
U.S.A.
Tel: (1) 818 354 83 30
Fax: (1) 818 393 66 86
E-mail: igsbc@igsbc.jpl.nasa.gov

**South Pacific Regional Environment
Programme (SPREP)**

Dr. C. Caluwin
Climate Change Officer
P.O. Box 240
Western Samoa
Tel: (685) 21 929
Fax: (685) 20 231
E-mail: sprep@pactok.apc.org

ANNEX X

SELECTED ACRONYMS

AAGN	Afro-America GLOSS News
ASEAN	Association of South East Asian Nations
AVISO	Archiving, Validation and Interpretation of Satellite Data in Oceanography (France)
BODC	British Oceanographic Data Centre
CERSAT	Centre ERS d'Archivage et de Traitement (France)
CIESM	Commission Internationale pour l'Exploration Scientifique de la Mer Méditerranée
CLIVAR	Climate Variability and Predictability
CMSLT	Commission on MSL and Tides of IAPSO
CTD	Conductivity, Temperature, Depth oceanographic instrument
DAC	Data Assembly Centre
DORIS	Doppler Orbitography and Radiopositioning Integrated by Satellite
ENVISAT	Environmental Satellite (European Space Agency)
ERS-1/2	European Remote Sensing Satellite -1/2 (European Space Agency)
EU	European Union
EUREF	European Reference Frame (an IAG Commission)
FAGS	Federation of Astronomical and Geophysical Data Analysis Services
FCCC	United Nations Framework Convention on Climate Change
FTP	File Transfer Protocol
GCOS	Global Climate Observing System
GEWEX	Global Energy and Water Cycle Experiment
GFO	Geosat Follow-On
GLOSS	Global Sea Level Observing System
GLOSS-ALT	GLOSS subset used for ALTimetry calibrations
GLOSS-OC	GLOSS subset used for ongoing ocean circulation monitoring
GOOS	Global Ocean Observing System
GTOS	Global Terrestrial Observing System
GPS	Global Positioning System
GSC	GOOS Steering Committee
IAC	International Archiving Centre
IAG	International Association for Geodesy
IAPSO	International Association for the Physical Sciences of the Ocean
ICSU	International Council of Scientific Unions
IERS	International Earth Rotation Service
IGBP	International Geosphere Biosphere Programme
IGCP	International Geological Correlation Programme
IGOSS	Integrated Global Ocean Services System
IHO	International Hydrographic Organisation
I-GOOS	IOC-WMO-UNEP Intergovernmental Committee for GOOS
IGS	International GPS Service for Geodynamics
ILP	International Lithosphere Programme
INQUA	International Union for Quaternary Research
IOC	Intergovernmental Oceanographic Commission of UNESCO
IPCC	Intergovernmental Panel on Climate Change
ITRF	International Terrestrial Reference Frame
IUGG	International Union of Geodesy and Geophysics
IUGS	International Union of Geological Sciences
JASON	New name for the TPFO (not an acronym)
J-GOOS	IOC-ICSU-UNEP-WMO Joint Scientific and Technical Steering Committee for GOOS (to be absorbed at end of 1997 into a new GOOS Steering Committee)

JSC	Joint ICSU-WMO Scientific Committee for the WCRP
LOICZ	Land-Ocean Interactions in the Coastal Zone (IGBP)
MEDS	Marine Environmental Data Service (Canada)
MSL	Mean Sea Level
MSS	Mean Sea Surface
NOAA	National Oceanic and Atmospheric Administration (USA)
NODC	National Oceanographic Data Center (USA)
NTF	National Tidal Facility (of Australia)
OOPC	Ocean Observation Panel for Climate (WCRP-GOOS-GCOS)
OOSDP	Ocean Observing System Development Panel (WCRP-GOOS-GCOS)
PGR	Post Glacial Rebound
PODAAC	Physical Oceanography Distributed Active Archive Center (Jet Propulsion Laboratory, USA)
POL	Proudman Oceanographic Laboratory (UK)
PRARE	Precise Range and Range Rate Equipment
PSMSL	Permanent Service for Mean Sea Level
QC	Quality Control
RLR	Revised Local Reference (of the PSMSL)
RQDS	Research Quality Data Set (of UHSLC)
SLR	Satellite Laser Ranging (or Sea Level Rise)
SOSLC	Southern Ocean Sea Level Centre (of NTF)
SSP	Sub-Surface Pressure
SSTOP	Sea Surface Topography
TEM ₁	Training, Education and Mutual Assistance (UNESCO-IOC)
TGBM	Tide Gauge Bench Mark
TOGA	Tropical Ocean Global Atmosphere
T/P	TOPEX/POSEIDON
TPFO	TOPEX/POSEIDON Follow-On (now called JASON)
UHSLC	University of Hawaii Sea Level Center
UNCED	United Nations Conference on Environment and Development
UNDP	United Nations Development Programme
UNEP	United Nations Environment Programme
UNESCO	United Nations Educational, Scientific and Cultural Organisation
UOP	Upper Ocean Panel (of CLIVAR)
VLBI	Very Long Baseline Interferometry
WCRP	World Climate Research Programme
WMO	World Meteorological Organisation
WOCE	World Ocean Circulation Experiment
WWW	World Wide Web
XBT	Expendible Bathythermograph oceanographic instrument